

User Manual Of iSV2-CAN Series Integrated Servo Motor

Version 0.2

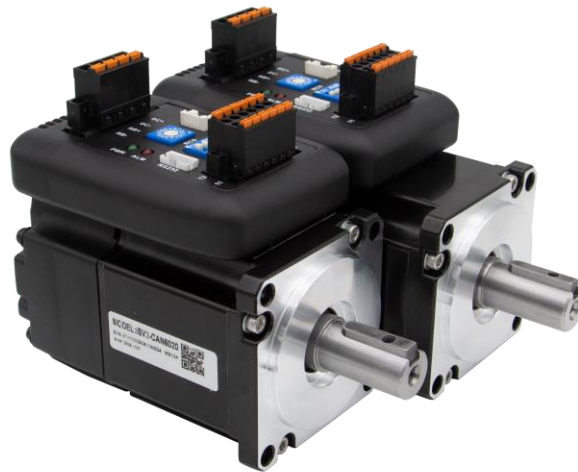

Introduction

Thanks for purchasing Leadshine iSV2 series integrated servo motor, this instruction manual provides knowledge and attention for using this motor.

Contact tech@leadshine.com for more technical service .

Incorrect operation may cause unexpected accident, please read this manual carefully before using product.

- ✧ We reserve the right to modify equipment and documentation without prior notice.
- ✧ We won't undertake any responsibility with customer's any modification of product, and the warranty of product will be cancel at the same time.

Be attention to the following warning symbol:



Warning

indicates that the error operation could result in loss of life or serious injury.



Caution

indicates that the error operation could result in operator injured, also make equipment damaged.



Attention

indicates that the error use may damage product and equipment.

Safety precautions



Warning

- The design and manufacture of product doesn't use in mechanic and system which have a threat to operator.
- The safety protection must be provided in design and manufacture when using this product to prevent incorrect operation or abnormal accident.

Acceptance



Caution

- The product which is damaged or have fault is forbidden to use.

Transportation



Caution

- The storage and transportation must be in normal condition.
- Don't stack too high, prevent falling.
- The product should be packaged properly in transportation,
- Don't hold the product by the cable, motor shaft or encoder while transporting it.
- The product can't undertake external force and shock.

Wiring



Warning

- The workers of participation in wiring or checking must possess sufficient ability do this job.
- Ground the earth terminal of the motor and drive without fail.
- The wiring should be connected after servo drive and servo motor installed correctly.
- After correctly connecting cables, insulate the live parts with insulator.



Caution

- The wiring must be connected correctly and steadily, otherwise servo motor may run incorrectly, or damage the equipment.
- We mustn't connect capacitors, inductors or filters between servo motor and servo drive.
- The wire and temperature-resistant object must not be close to radiator of servo drive and motor.
- The freewheel diode which connect in parallel to output signal DC relay mustn't connect reversely.

Debugging and running



Caution

- Make sure the servo drive and servo motor installed properly before power on, fixed steadily, power voltage and wiring correctly.
- The first time of debugging should be run without loaded, debugging with load can be done after confirming parameter setting correctly, to prevent mechanical damage because of error operation.



Caution

- Install a emergency stop protection circuit externally, the protection can stop running immediately to prevent accident happened and the power can be cut off immediately.
- The run signal must be cut off before resetting alarm signal, just to prevent restarting suddenly.
- The servo drive must be matched with specified motor.
- Don't power on and off servo system frequently, just to prevent equipment damaged.
- Forbidden to modify servo system.

Fault Processing



Caution

- The reason of fault must be figured out after alarm occurs, reset alarm signal before restart.
- Keep away from machine, because of restart suddenly if the drive is powered on again after momentary interruption(the design of the machine should be assured to avoid danger when restart occurs)

System selection



Attention

- The rate torque of servo motor should be larger than effective continuous load torque.
- The ratio of load inertia and motor inertia should be smaller than recommended value.
- The servo drive should be matched with servo motor.

Table of Contents

Introduction	2
Chapter 1 Introduction.....	7
1.1 Product Introduction.....	7
1.1.1 Specification and feature	7
1.1.2 Part Numbering Information	8
1.2 Inspection of product.....	8
Chapter 2 Installation	9
2.1 Storage and Installation Circumstance	9
2.2 Servo Drive Installation.....	9
Chapter 3 Wiring	10
3.1 Wiring.....	10
3.1.1 Wire Gauge.....	10
3.1.2 Wiring.....	12
3.2 Drive Terminals Function.....	13
3.2.1 Control Signal Port-CN1 Terminal	13
3.2.2 Power Port	14
3.2.3 Communication Port.....	14
3.2.4 CAN bus connector	14
3.2.5 CAN Node-ID and Baud rate switch.....	14
3.3 I/O Interface Principle	15
3.3.1 Digital Input Interface	15
3.3.2 Digital Output Interface.....	15
Chapter 4 Parameter	18
4.1 Parameter List	18
4.1.1 Drive Parameters (Group 2000h)	18
4.1.2 Manufacturer Parameters (Group 5000h).....	21
4.1.3 Device Profile Parameters (Group 6000h)	23
4.2 Parameters Function	25
4.2.1 【Class 0】 Basic Setting	25
4.2.2 【Class 1】 Gain Adjust	29
4.2.3 【Class 2】 Vibration Suppression.....	33
4.2.4 【Class 3】 Velocity/ Torque Control.....	35
4.2.5 【Class 4】 I/F Monitor Setting	36
4.2.6 【Class 5】 Extended Setup	41
4.2.7 【Class 6】 Special Setup.....	44
4.2.8 【Class 7】 Factory setting.....	46
4.3 402 Parameters Function	47
Chapter 5 CANopen	52
5.1 CAN Interface	52
5.2 CANopen protocol	52
5.2.1 CANopen frame	52
5.2.2 CANopen objects	53

5.3 NMT.....	54
5.3.1 NMT services	55
5.3.1 NMT error control	55
5.4 SDO.....	57
5.5 PDO.....	58
5.6 SYNC	59
5.7 EMCY	59
Chapter 6 Trial Run	61
6.1 Inspection Before trial Run	61
6.2 iSV2-CAN motion control procedure	61
6.3 CIA 402 State Machine	62
6.4 Common Functions for All Modes	63
6.4.1 Motor Rotation Direction	63
6.2.2 Drive Stop.....	63
6.4.3 Electronic Gear Ratio	63
6.4.4 Control Word	64
6.4.5 Status Word.....	64
6.4.6 Drive Enable.....	65
6.5 Profile position mode	66
6.5.1 Controlword in profile position mode	66
6.5.2 Statusword in profile position mode	67
6.5.3 Related objects	67
6.5.4 Example of profile position mode	68
6.6 Profile velocity mode	68
6.6.1 Controlword in profile velocity mode	69
6.6.2 Statusword in profile velocity mode.....	69
6.6.3 Related objects	69
6.6.4 Example of profile velocity mode	70
6.7 Profile torque mode	70
6.7.1 Controlword in profile torque mode	70
6.7.2 Statusword in profile torque mode	71
6.7.3 Related objects	71
6.7.4 Example of profile torque mode	72
6.8 Homing mode	72
6.8.1 Controlword in profile homing mode	72
6.8.2 Statusword in profile homing mode	73
6.8.3 Related objects	74
6.8.4 Example of homing mode	74
6.8.5 Homing Method	75
6.9 Security Features	89
6.9.1 BRK-OFF output	89
6.9.2 Servo stop mode	91
6.9.3 Emergency stop function	91
6.10 Inertia ratio identification	91

6.10.1 On-line inertia ratio identification	91
6.10.2 Motion Studio inertia ratio identification	91
6.11 Vibration Suppression.....	92
6.12 Friction torque compensation.....	94
6.13 Regenerative resistor setting.....	94
Chapter 7 Alarm and Processing	96
7.1 Alarm List.....	96
7.2 Alarm Processing Method	98
Chapter 8 Product Accessory	106
8.1 Accessory selection	106
Contact us	107

Chapter 1 Introduction

1.1 Product Introduction

iSV2-CAN integrated servo is a special motion control product designed for machines and applications that request a best balance between outstanding and reasonable cost.

Based on CIA DS 301+DSP 402 sub-protocol, it can be seamlessly connected to the controller/drive that supports this standard protocol.

◆ Basic specification

- ◇ Up to 750watt
- ◇ Frame size : 60mm, 80mm
- ◇ Voltage input : 20-70vdc
- ◇ Encoder : 17bit incremental
- ◇ Motor with or without brake
- ◇ 2.5 – 3 times overload
- ◇ 4 programmable input
- ◇ 2 programmable output
- ◇ RS232 for configuration

◆ CANopen Communication

- ◇ Up to 128 axes supported in one network
- ◇ Link Layer Protocol : CAN Field-bus
- ◇ Application Layer Protocol : CANopen Protocol
- ◇ CAN-ID type : CAN 2.0A
- ◇ Communication Rate : 1M/500k/250k/100k/50k/20k bit/s
- ◇ Sub-protocol :DS301 V4.02 , DSP 402 V2.0
- ◇ PDO Transmission Modes : Time trigger/event trigger/asynchronization/synchronization
- ◇ Control mode : profile position, profile velocity , profile torque , homing

1.1.1 Specification and feature

Part Number	iSV2-CAN6020V24*	iSV2-CAN6020V48*	iSV2-CAN6040V48*	iSV2-CAN8075V48*
Rated Power(W)	200	200	400	750
Rated Torque(Nm)	0.64	0.64	1.27	2.4
Peak Torque(Nm)	1.92	1.92	3.81	7.2
Rated Speed(rpm)	3000	3000	3000	3000
Peak Speed(rpm)	4000	4000	4000	4000
Rated Voltage(Vdc)	24	48	48	48
Weight(kg)	0.95	0.95	1.25	-
Input Voltage(Vdc)	24~50	24~70	24~70	24 -70
Continuous Current(Arms)	11	6.5	10	19
Peak Current(A)	34	20	28	57
Logic Signal Current(mA)	10	10	10	10
Isolation Resistance(MΩ)	100	100	100	-
Control method	IGBT PWM sinusoidal Wave Drive			
Overload	250% ~ 300%			
Brake resistor	External connection			
Protection rank	IP20			

Features			
Drive model	iSV2-CAN6020*	iSV2-CAN6040*	iSV2-CAN8075*
Modes of operation	Profile Position/Profile Velocity/Profile Torque		
Command source	Over the Network		
Inputs/Outputs	4 programmable single-end inputs(24V); 2 programmable single-end outputs.		
Brake Output (24vdc)	√		
Feedback Supported	17bit Incremental		
Communication	CANopen , RS-232 for tuning		

1.1.2 Part Numbering Information

iSV2- CAN 6040 V48 G

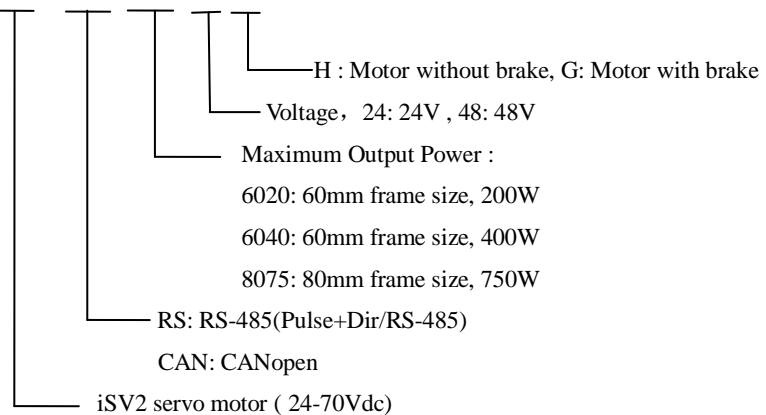

1.2 Inspection of product

Check the following thing before using the products :

- Check if the product is damaged or not during transportation.
- Check if the servo drive & motor are complete or not.
- Check the packing list if the accessories are complete or not

Chapter 2 Installation

2.1 Storage and Installation Circumstance

Table 2.1 Servo Motor Storage Circumstance Requirement

Item	iSV2 series motor
Temperature	-20-80°C
Humidity	Under 90%RH (free from condensation)
Atmospheric environment	Indoor(no exposure)no corrosive gas or flammable gas, no oil or dust
Altitude	Lower than 1000m
Vibration	Less than 0.5G (4.9m/s ²) 10-60Hz (non-continuous working)
Protection level	IP20

Table 2.2 Servo Motor Installation Circumstance Requirement

Item	iSV2 series motor
Temperature	0-80°C
Humidity	Under 90%RH(free from condensation)
Atmospheric environment	Indoor(no exposure)no corrosive gas or flammable gas, no oil or dust
Altitude	Lower than 1000m
Vibration	Less than 0.5G (4.9m/s ²) 10-60Hz (non-continuous working)
Protection level	IP20(no protection)

2.2 Servo Drive Installation



Notice

- Must install in control cabinet with sufficient safeguarding grade.
- Must install with specified direction and intervals, and ensure good cooling condition.
- Don't install them on inflammable substance or near it to prevent fire hazard.



Notice

- Don't hold the product by the cable, motor shaft or encoder while transporting it.
- No knocking motor shaft or encoders, prevent motor by vibration or shock.
- The motor shaft can't bear the load beyond the limits.
- Motor shaft does not bear the axial load, radial load, otherwise you may damage the motor.
- Use a flexible with high stiffness designed exclusively for servo application in order to make a radial thrust caused by micro misalignment smaller than the permissible value.
- Install must be steady, prevent drop from vibrating.

Chapter 3 Wiring



Warning

- The workers of participation in wiring or checking must possess sufficient ability do this job.
- The wiring and check must be going with power off after five minutes.



Caution

- Ground the earth terminal of the motor and drive without fail.
- The wiring should be connected after servo drive and servo motor installed correctly

3.1 Wiring

3.1.1 Wire Gauge

(1) Power supply terminal TB

- Wiring Diameter:

Drive	Wiring diameter (mm ² /AWG)	
	Vdc, GND	PE
iSV2-CAN6020V24*	AWG16	AWG16
iSV2-CAN6020V48*	AWG16	AWG16
iSV2-CAN6040V48*	AWG16	AWG16
iSV2-CAN8075V48*	AWG14	AWG14

- Grounding: The grounding wire should be as thick as possible, servo motor the PE terminal point ground, ground resistance <100 Ω.

● Use noise filter to remove external noise from the power lines and reduce an effect of the noise generated by the servo drive.

- Install fuse (NFB) promptly to cut off the external power supply if drive error occurs.

(2) The control signal CN1

● Diameter: shielded cable (twisting shield cable is better), the diameter $\geq 0.14\text{mm}^2$ (AWG24-26), the shield should be connected to FG terminal.

● Length of line: cable length should be as short as possible and control CN1 cable is no more than 3 meters, the CN2 cable length of the feedback signal is no more than 10 meters.

- Wiring: be away from the wiring of power line, to prevent interference input.

● Install a surge absorbing element for the relevant inductive element (coil), DC coil should be in parallel connection with freewheeling diode reversely; AC coil should be in parallel connection with RC snubber circuit.

(3) Regenerative resistor

When the torque of the motor is opposite to the direction of rotation (common scenarios such as deceleration, vertical axis descent, etc.), energy will feedback from the load to the drive. At this time, the energy feedback is first received by the capacitor in the drive, which makes the voltage of the capacitor rise. When it rises to a certain voltage value, the excess energy needs to be consumed by the regenerative resistance

The recommended regenerative resistance specifications for the iSV2 series are as follows:

Drive	Recommend resister value (Ω)	Recommend resister power (W)
iSV2-CAN6020V24*	10	50
iSV2-CAN6020V48*	10	50

iSV2-CAN6040V48*	10	50
iSV2-CAN8075V48*	10	100

Method for select regenerative resistance specification

- Firstly, use the built-in resistance of the drive to run for a long time to see if it can meet the requirements: ensure that the drive temperature $d33 < 60^{\circ}\text{C}$, the braking circuit does not alarm (Regeneration load factor $d14 < 80$), and the drive does not report overvoltage error
- If the drive temperature is high, try to reduce the regenerative energy power, or external resistance of the same specification (in this case, cancel the built-in resistance).
- If the brake resistance burns out, try to reduce the regenerative energy power, or put an external resistance of the same specification or even more power (in this case, cancel the built-in resistance).
- If $d14$ is too large or accumulates too fast, it means that the regenerative energy is too large, and the built-in resistance cannot consume the generated energy, the regenerative energy power will be reduced, or the external resistance with higher resistance value or power will be reduced.
- If an overvoltage error is reported by the drive, the regenerative energy power is reduced, or a resistance with a smaller external resistance, or a parallel resistance.

The recommended regenerative resistance specifications for the iSV2 series are as follows:

10Ω \pm 5%, 100w RXFB-1,

Part num Code : 10100469



Attention

- Match the colors of the motor lead wires to those of the corresponding motor output terminals (U.V.W)
- Never start nor stop the servo motor with this magnetic contactor.

3.1.2 Wiring

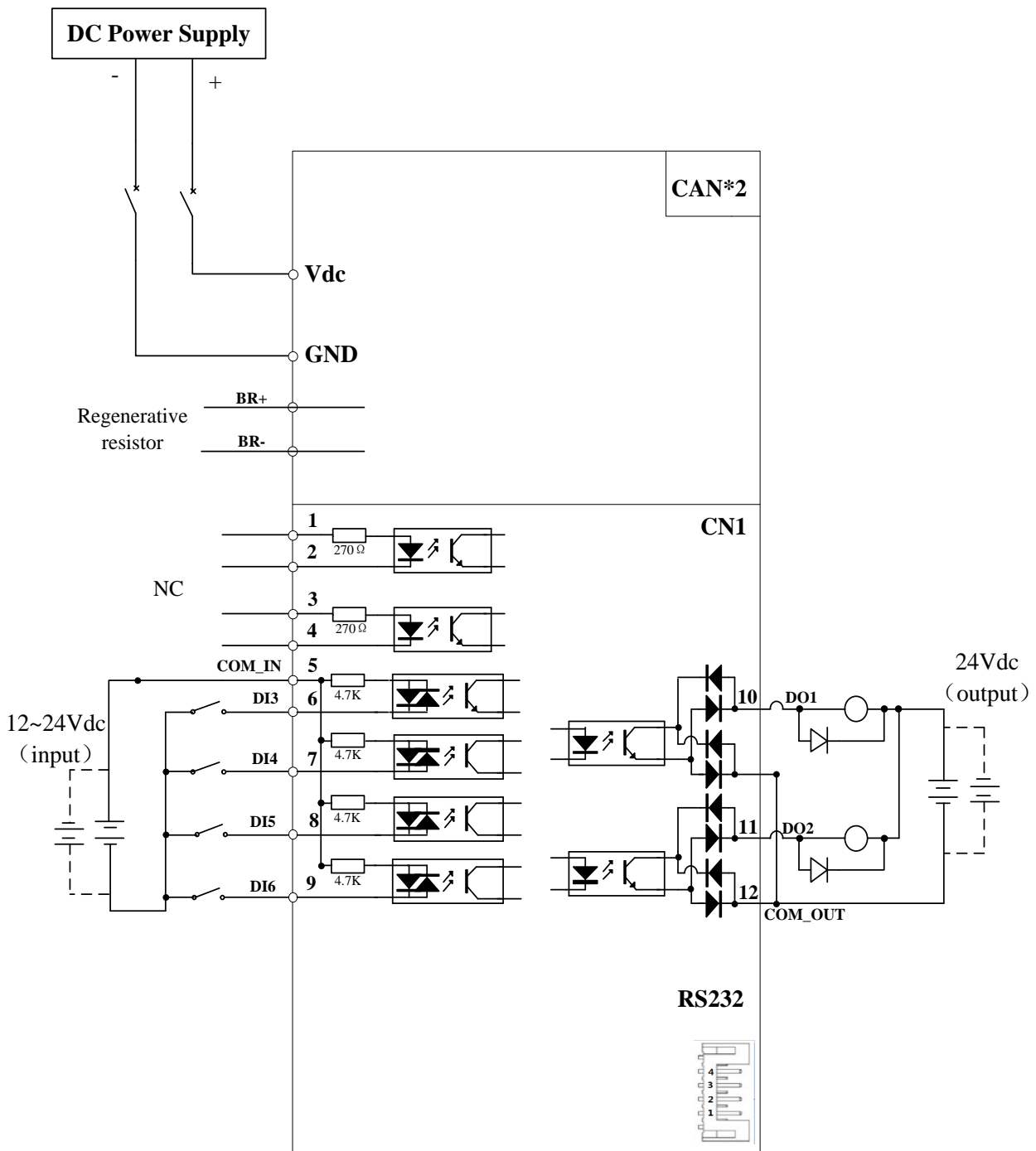

Figure 3.1 Position Control Mode Wiring

Notes:

1. 4 digital inputs DI3~DI6, support NPN and PNP connection, recommend 12~24V input signal.
2. 2 digital outputs DO1~DO2, support NPN and PNP connection, recommend 24V output signal.

3.2 Drive Terminals Function

Port	Function
CN1	Control Signal Port
CN2	Power Port
CN3	RS232 Communication Port
CN4	CAN Communication Port
RCS	CAN slave axis ID
SW1~4	CAN Baud rate \ Terminal resistance

3.2.1 Control Signal Port-CN1 Terminal

Table 3.1 Signal Explanation of Control Signal Port-CN1

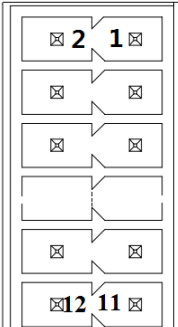
CN1	Pin	Signal	IO	Detail
	1	NC	Input	Reserved
	2	NC	Input	
	3	NC	Input	Reserved
	4	NC	Input	
	5	COMI	Input	Power supply positive terminal of the external input control signal, 12V ~ 24V
	6	DI3	Input	Digital input signal 3, default value is E-STOP signal, low level available in default , max voltage is 24V input 20KHz
	7	DI4	Input	Digital input signal 4, default value is homing switch signal(HOME-SWITCH) , low level available in default , max voltage
	8	DI5	Input	Digital input signal 5, default value is Positive limit switch signal(POT), low level available in default , max voltage is 24V input 20KHz
	9	DI6	Input	Digital input signal 6, default value is Negative limit switch signal (NOT), low level available in default , max voltage is 24V input 20KHz
	10	DO1	Output	Digital output signal 1 , default value is alarm output , 24V, <100mA
	11	DO2	Output	Digital output signal 2 , default value is servo-ready output , 24V, <100mA
	12	COMO	Output	Digital output signal commonality ground, 24V

3.2.2 Power Port

CN2	Pin	Signal	Description
CN2	1	DC+	Power Supply Input (Positive)24-70VDC recommended. Please leave reasonable reservation for voltage fluctuation and back-EMF during deceleration.
	2	DC-	Power Ground (Negative)
	3	RBR+	Regenerative resistor +
	4	RBR-	Regenerative resistor -

The recommend resistor for most application is 10Ω+/-5%, 100watt

Leadshine can provide resistor: **RXFB-1, Part num Code : 10100469**

3.2.3 Communication Port

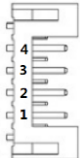
CN3		Pin	Signal
RS232		1	5V
		2	TX
		3	GND
		4	RX

3.2.4 CAN bus connector

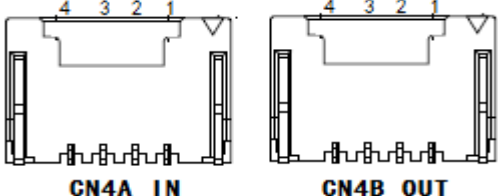
CN4		Pin	Signal
CAN		1	CANH
		2	CANL
		3	GND
		4	PE

3.2.5 CAN Node-ID and Baud rate switch

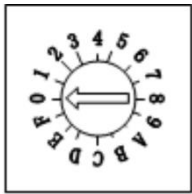
RCS		NO	CAN Node-ID	NO	CAN Node-ID
		0	Pr0.23 Default =16	8	8
		1	1	9	9
		2	2	A	10
		3	3	B	11
		4	4	C	12
		5	5	D	13
		6	6	E	14
		7	7	F	15

If switch S1=0, then Pr0.23 valid.

If switch S1=1~F, S1 switch valid in higher priority than Pr0.23

CAN Baud rate	SW1	SW2
Pr0.24 Default =1MHz	off	off
500 KHz	on	off
250 KHz	off	on
125 KHz	on	on

If SW1 and SW2 OFF, then Pr0.24 valid

If SW1 or SW2 ON, then these switch valid in higher priority than Pr0.24

SW3: CAN terminal resistor

SW3=off, disconnect the terminal resistance

SW3=on, connect the terminal resistance

SW4: CAN Node-ID selection (High Bit)

SW4=off, High Bit =0, CAN Node-ID=RCS

SW4=on, High Bit =1, CAN Node-ID =16+RCS

3.3 I/O Interface Principle

3.3.1 Digital Input Interface

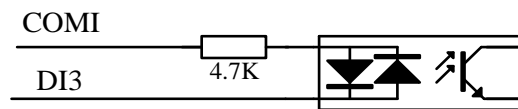

Figure 3-2 Digital Input Interface

- (1) The user provide power supply, DC 12-24V, current \geq 100mA
- (2) **Notice:** if current polar connect reversely, servo motor doesn't run.

3.3.2 Digital Output Interface

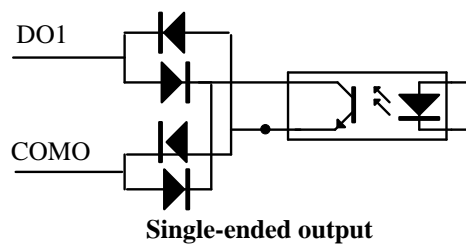

Figure 3-3 Switch Output Interface

- (1) 2 digital single-ended outputs DO1~DO2, support NPN and PNP connection, recommend 24V output signal.
- (2) If the load is inductive loads relays, etc., there must be anti-parallel freewheeling diode across the load. If the freewheeling diode is connected reversely, the servo drive is damaged.

Digital Input function allocation

Pr4.02	Name	Input selection DI3			Mode						F
	Range	0~00FFFFFFh	Unit	—	Default	0x14	Index	2402h			
Pr4.03	Name	Input selection DI4			Mode						F
	Range	0~00FFFFFFh	Unit	—	Default	0x16	Index	2403h			

Pr4.04	Name	Input selection DI5			Mode						F
	Range	0~00FFFFFFh	Unit	—	Default	0x01	Index		2404h		
Pr4.05	Name	Input selection DI6			Mode						F
	Range	0~00FFFFFFh	Unit	—	Default	0x02	Index		2405h		

Assign functions to digital inputs.

This parameter use 16 binary system to set up the values,

For the function number, please refer to the following table.

Signal	Symbol	Setup Value		0x60FD(bit)
		Normally open	Normally closed	
Invalid	—	00h	Do not setup	×
Positive direction over-travel inhibition input	POT	01h	81h	1
Negative direction over-travel inhibition input	NOT	02h	82h	0
Alarm clear input	A-CLR	04h	Do not setup	
Forced alarm input	E-STOP	14h	94h	
HOME-SWITCH	HOME-SWITCH	16h	96h	2

- Normally open means input signal comes from external controller or component, for example: PLC .
- Normally closed means input signal comes from drive internally.
- Don't setup to a value other than that specified in the table .
- Don't assign specific function to 2 or more signals. Duplicated assignment will cause Err210 I/F input multiple assignment error 1or Err211 I/F input multiple assignment error 2.
- E-STOP: Associated parameter Pr4.43

I/O input digital filtering

Pr5.15 *	Name	I/O reading filter			Mode						F
	Range	0~255	Unit	0.1ms	Default	0	Index		2515h		

I/O input digital filtering; higher setup will arise control delay.

Digital Output function allocation

Pr4.10	Name	Output selection DO1			Mode						F
	Range	0~00FFFFFFh	Unit	—	Default	0x01	Index		2410h		
Pr4.11	Name	Output selection DO2			Mode						F
	Range	0~00FFFFFFh	Unit	—	Default	0x02	Index		2411h		

Assign functions to digital outputs.

For the function number, please refer to the following table.

Signal name	Symbol	Setup value	
		Normally open	Normally closed
Master control output	—	00h	Do not setup
Alarm output	Alm	81h	01h
Servo-Ready output	S-RDY	02h	82h
Eternal brake release signal	BRK-OFF	03h	83h
Positioning complete output	INP	04h	84h
At-speed output	AT-SPPED	05h	85h
Torque limit signal output	TLC	06h	86h
Zero speed clamp detection output	ZSP	07h	87h
Velocity coincidence output	V-COIN	08h	88h
Positional command ON/OFF output	P-CMD	0Bh	8Bh
Speed limit signal output	V-LIMIT	0Dh	8Dh
Speed command ON/OFF output	V-CMD	0Fh	8Fh
Servo enable state output	SRV-ST	12h	92h
Homing process finish	HOME-OK	22h	A2h

- Normally open: Active low
- Normally closed: Active high
- Don't setup to a value other than that specified in the table .
- Pr4.10~Pr4.11 correspond to DO1~DO2 respectively.

Chapter 4 Parameter

4.1 Parameter List

4.1.1 Drive Parameters (Group 2000h)

Mode						Parameter Number		Name	CANopen Address	Parameters	
						Classify	Num				
					F	[Class 0] Basic setting	00	MFC function	2000h	Pr_000	
					F		01	control mode setup	2001h	Pr_001	
					F		02	real-time auto-gain tuning	2002h	Pr_002	
					F		03	selection of machine stiffness at real-time auto-gain tuning	2003h	Pr_003	
					F		04	Inertia ratio	2004h	Pr_004	
							06	Rotation direction setup	2006h	Pr_006	
PP	PV		HM				08	Command pulse per one motor revolution	2008h	Pr_008	
					F		13	1st torque limit	2013h	Pr_023	
PP			HM				14	position deviation excess setup	2014h	Pr_014	
							15	Absolute encoder setup	2015h	Pr_015	
					F		16	External regenerative resistance value	2016h	Pr_016	
					F		17	External regenerative resistance power value	2017h	Pr_017	
					F		23	CAN Node ID	2023h	Pr_023	
					F		24	CAN baud rate	2024h	Pr_024	
							25	Synchronous compensation time 1	2025h	Pr_025	
							26	Synchronous compensation time 2	2026h	Pr_026	
PP			HM				[Class 1] Gain Adjust	00	1st gain of position loop	2100h	Pr_100
					F			01	1st gain of velocity loop	2101h	Pr_101
					F			02	1st time constant of velocity loop integration	2102h	Pr_102
					F			03	1st filter of velocity detection	2103h	Pr_103
					F			04	1st time constant of torque filter	2104h	Pr_104
PP			HM					05	2nd gain of position loop	2105h	Pr_105
					F			06	2nd gain of velocity loop	2106h	Pr_106
					F			07	2nd time constant of velocity loop integration	2107h	Pr_107
					F			08	2nd filter of velocity detection	2108h	Pr_108
					F			09	2nd time constant of torque filter	2109h	Pr_109
PP			HM			10		Velocity feed forward gain	2110h	Pr_110	
PP			HM			11		Velocity feed forward filter	2111h	Pr_111	
PP	PV		HM			12	Torque feed forward gain	2112h	Pr_112		

Mode						Parameter Number		Name	CANopen Address	Parameters
						Classify	Num			
PP	PV		HM				13	Torque feed forward filter	2113h	Pr_113
						F	15	Control switching mode	2115h	Pr_115
						F	17	Control switching level	2117h	Pr_117
						F	18	Control switch hysteresis	2118h	Pr_118
						F	19	Gain switching time	2119h	Pr_119
						F	37	Special register	2137h	Pr_137
							00	adaptive filter mode setup	2200h	Pr_200
						F	01	1st notch frequency	2201h	Pr_201
						F	02	1st notch width selection	2202h	Pr_202
						F	03	1st notch depth selection	2203h	Pr_203
						F	04	2nd notch frequency	2204h	Pr_204
						F	05	2nd notch width selection	2205h	Pr_205
						F	06	2nd notch depth selection	2206h	Pr_206
						F	07	3rd notch frequency	2207h	Pr_207
						F	14	1st damping frequency	2214h	Pr_214
						F	15	1st damping filter setup	2215h	Pr_215
PP			HM				22	Positional command smooth filter	2222h	Pr_222
PP			HM				23	Positional command FIR filter	2223h	Pr_223
	PV						12	time setup acceleration	2312h	Pr_312
	PV						13	time setup deceleration	2313h	Pr_313
	PV						14	Sigmoid acceleration/ deceleration time setup	2314h	Pr_314
	PV						16	Speed zero-clamp level	2316h	Pr_316
							23	Speed mode zero speed static	2323h	Pr_323
						F	00	input selection DI1	2400h	Pr_400
						F	01	input selection DI2	2401h	Pr_401
						F	02	input selection DI3	2402h	Pr_402
						F	03	input selection DI4	2403h	Pr_403
						F	04	input selection DI5	2404h	Pr_404
						F	05	input selection DI6	2405h	Pr_405
						F	10	output selection DO1	2410h	Pr_410
						F	11	output selection DO2	2411h	Pr_411
PP			HM				31	Positioning complete range	2431h	Pr_431
PP			HM				32	Positioning complete output setup	2432h	Pr_432
PP			HM				33	INP hold time	2433h	Pr_433
						F	34	Zero-speed	2434h	Pr_434
	PV						35	Speed coincidence range	2435h	Pr_435
	PV						36	At-speed	2436h	Pr_436
						F	37	Mechanical brake action setting when stopping	2437h	Pr_437
						F	38	Mechanical brake action setting	2438h	Pr_438
						F	39	Brake release speed setup	2439h	Pr_439
						F	43	E-stop function active	2443h	Pr_443
						F	04	Drive inhibit input setup	2504h	Pr_504
						F	06	Sequence at servo-off	2506h	Pr_506

Mode						Parameter Number		Name	CANopen Address	Parameters
						Classify	Num			
					F	[Class 5] Extended Setup	08	Main power off LV trip selection	2508h	Pr_508
					F		09	Main power off detection time	2509h	Pr_509
							10	Dynamic braking mode	2510h	Pr_510
							11	Torque setup for emergency stop	2511h	Pr_511
					F		12	Over-load level setup	2512h	Pr_512
					F		13	Over-speed level setup	2513h	Pr_513
PP			HM				20	Position setup unit select	2520h	Pr_520
					F		21	Selection of torque limit	2521h	Pr_521
					F		22	2nd torque limit	2522h	Pr_522
							33	Touch probe 1 signal compensation time	2533h	Pr_533
							34	Touch probe 2 signal compensation time	2534h	Pr_534
							37	Torque saturation alarm detection time	2537h	Pr_537
							39	3rd torque limit	2539h	Pr_539
							[Class 6] Special Setup	01	Encoder zero position compensation	2601h
PP			HM			04		JOG trial run command speed	2604h	Pr_604
PP			HM			05		Position 3rd gain valid time	2605h	Pr_605
PP			HM			06		Position 3rd gain scale factor	2606h	Pr_606
					F	07		Torque command additional value	2607h	Pr_607
					F	08		Positive direction torque compensation value	2608h	Pr_608
					F	09		Negative direction torque compensation value	2609h	Pr_609
						11		Current response setup	2611h	Pr_611
						12		Setting of torque limit for zero correction of encoder.	2612h	Pr_612
					F	13		2nd inertia ratio	2613h	Pr_613
					F	14		Emergency stop time at alarm	2614h	Pr_614
						20		distance of trial running	2620h	Pr_620
						21		waiting time of trial running	2621h	Pr_621
						22		cycling times of trial running	2622h	Pr_622
						25	Acceleration of trial running	2625h	Pr_625	
						26	Mode of trial running	2626h	Pr_626	
						34	Frame error window time	2634h	Pr_634	
						35	Frame error window	2635h	Pr_635	

Mode						Parameter Number		Name	CANopen Address	Parameters
						Classify	Num			
							61	Z signal duration time	2661h	Pr_661
							62	Overload warning threshold	2662h	Pr_662
							63	upper limit of multi - turn absolute position	2663h	Pr_663

4.1.2 Manufacturer Parameters (Group 5000h)

Index	Sub-index	Name	Unit	Default	Min	Max	Details
5004	01	RPDO length		8	0	64	
	02	TPDO length		17	0	64	
	03	The number of RPDO		1	0	4	
	04	The number of TPDO		1	0	2	
	05	Sync0 Watchdog counter		0	0	65535	
	06	Reserved			0	65535	
	07	Sync0 Watchdog limit		4	0	65535	73B alarm threshold, set to 0 is shielding
	08	Sync0 Drift watchdog counter		0	0	65535	
	09	Sync0 Drift watchdog limit		4	0	65535	73C alarm threshold, set to 0 is shielding
	0A	SM2 watchdog counter		0	0	65535	
	0B	SM2 Watchdog limit		4	0	65535	73A alarm threshold, set to 0 is shielding
	0C	Application layer SM2/Sync0 watchdog counter		0			
	0D	Application layer SM2/Sync0 watchdog limit		4			
	0E	Reserved			0	500	
	0F	Time interval between SM2 and Sync0	ns	0	0	1000000000	832h Alarm detection
5006	00	Synchronous alarm setting		0xFFFF	0	0xFFFF	Bit0: 818h Alarm enable switch Bit1: 819h Bit2: 81Ah Bit3: 824h Bit4: 825h Bit5: Reserved Bit6: Reserved Bit7: 82Ch Bit8: 82Dh Bit9: 832h Bit10~15: Reserved Notes: 0 invalid; 1 valid

5010	00	PDO watchdog overtime	ms	0	0	60000	0: invalid; > 0: valid; Unit: ms; Such as RPDO timeout alarm 818h, TPDO timeout alarm 819h		
5012	04	Homing setting	-	5	Bit0: Abnormal signal protection 0: invalid; 1: valid Bit1: pull back if over travel while final stop 0: invalid; 1: valid Bit2/Bit3:				
					Bit2	Bit3	Positive limit position	Negative limit position	Feedback after the homing process
					0	0	607D-02+ 607C	607D-01 + 607C	6064 = 607C
					0	1	607D-02- 607C	607D-01 - 607C	6064 = -607C
					1	-	607D-02	607D-01	6064 = 0
Bit4: Deal with Overtravel between the high speed and low speed during homing process 0: Homing process error (set 6041h bit13=1); 1: As normal, continue homing process									
5400	01	Set synchronization cycle minimum value	us	250	125	1000			
	02	Set synchronization cycle maximum value	us	10000	4000	20000			
5500	01	Absolute encoder multi turn number	r	-	-	-	-		
	02	Encoder single turn position	Pulse	-	-	-	-		
	03	Encoder feedback position 32 bit low	Pulse	-	-	-	-		
	04	Encoder feedback position 32 bit high	Pulse	-	-	-	-		
	05	The actual mechanical position 32 bit low	Unit	-	-	-	-		
	06	The actual mechanical position 32 bit high	Unit	-	-	-	-		
	07	Number of encoder communication exceptions		-	-	-	-		
5501	01	Motor Speed	r/min	-	-	-	-		
	02	Speed of position command	r/min	-	-	-	-		
	03	Speed command	r/min	-	-	-	-		
	04	Actual torque	0.1%	-	-	-	-		
	05	Torque command	0.1%	-	-	-	-		
	06	Relative position error	Pulse	-	-	-	-		

	07	Internal position command	Pulse	-	-	-	-
	08	Overload ratio	0.1%	-	-	-	-
	09	Discharge load rate	0.1%	-	-	-	-
	0A	Inertia ratio	%	-	-	-	-
	0B	Actual positive torque limit value	0.1%	-	-	-	-
	0C	Actual negative torque limit value	0.1%	-	-	-	-
	0D	U phase current detect value	0.1%	-	-	-	-
	0E	W phase current detect value	0.1%	-	-	-	-
5502	01	SI input signal	-	-	-	-	-
	02	DO output signal	-	-	-	-	-
	03	Reserved	-	-	-	-	-
	04	Reserved	-	-	-	-	-
	05	Bus voltage	V	-	-	-	-
	06	Temperature	°C	-	-	-	-
	07	Power on time	S	-	-	-	-

4.1.3 Device Profile Parameters (Group 6000h)

Index	Sub-index	Name	Unit	Default	Min	Max	Mode
603F	0	Error code	-	-	-	-	ALL
6040	0	Control word	-	-	-	-	ALL
6041	0	Status word	-	-	-	-	ALL
605A	0	Quick stop option code	-	6	0	7	ALL
605B	0	Shut down code	-	0	0	1	ALL
605C	0	Disable operation code	-	0	0	1	ALL
605D	0	Halt option code	-	1	1	4	ALL
605E	0	Alarm stop code	-	0	0	2	ALL
6060	0	Mode of operation	-	8	1	11	ALL
6061	0	Mode of operation display	-	-	-	-	ALL
6062	0	Position demand value	Command unit	-	-	-	pp/hm
6063	0	Actual internal position value	Encoder unit	-	-	-	ALL
6064	0	Actual feedback position value	Command unit	-	-	-	ALL
6065	0	Following error window	Command unit	10000	0	2147483647	PP
6066	0	Following error detection time	ms	10	0	65535	pp
606B	0	Internal command speed	Command unit	-	-	-	pv
606C	0	Actual feedback speed value	Command unit	-	-	-	ALL

6071	0	Target torque	0.1%	0	-32768	32767	pt
6072	0	Max torque	0.1%	3000	0	65535	ALL
6073	0	Max current	0.1%	-	-	-	ALL
6074	0	Internal torque command	0.1%	-	-	-	ALL
6075	0	Rated current	mA	-	-	-	ALL
6076	0	Rated torque	mN.M				
6077	0	Actual torque	0.1%	-	-	-	ALL
6079	0	Bus voltage	mV	-	-	-	ALL
607A	0	Target position	Command unit	0	-214748 3648	2147483 647	PP
607C	0	Homing position offset	Command unit	0	-214748 3648	2147483 647	ALL
607D	1	Minimum soft limit	Command unit	0	-214748 3648	2147483 647	PP
	2	Maximum soft limit	Command unit	0	-214748 3648	2147483 647	PP
607E	0	Motor rotation direction	-	0	0	255	ALL
607F	0	Maximum protocol speed (Restricted by 6080)	Command unit /s				
6080	0	Maximum motor speed	r/min	5000	0	6000	ALL
6081	0	protocol speed (Restricted by 607F)	Command unit /s	10000	0	2147483 647	PP
6083	0	Profile acceleration	Command unit /s/s	10000	1	2147483 647	pp/pv/
6084	0	Profile deceleration	Command unit /s/s	10000	1	2147483 647	pp/pv
6085	0	Quick stop deceleration	Command unit /s/s	100000 00	1	2147483 647	pp/pv/ hm
6087	0	Torque change rate	0.1%/s	100	1	2147483 647	pt
608F	1	Encoder resolution	Encoder unit	-	-	-	ALL
	2	Motor turns	-				
6091	1	Electron gear molecule	-	1	1	2147483 647	ALL
	2	Electronic gear denominator	-	1	1	2147483 647	ALL
6092	1	Number of pulses per rotation	Command unit	10000	1	2147483 647	ALL
	2	Number of physical axis turns	-				
6098	0	Homing method	-	19	-6	37	hm
6099	1	High speed of homing	Command unit /s	10000	0	2147483 647	hm
	2	Low speed of homing	Command unit /s	5000	0	2147483 647	hm
609A	0	Homing acceleration	Command unit /s ²	10000	0	2147483 647	hm
60B0	0	Position feedforward	Command unit	0	-214748 3648	2147483 647	
60B1	0	Velocity feedforward(Restricted by 6080)	Command unit /s	0	-214748 3648	2147483 647	pp/pv/ hm
60B2	0	Torque feedforward	0.1%	0	-32768	32767	ALL

60B8	0	Touch probe control word	-	0	0	65535	ALL
60B9	0	Touch probe statue word	-	-	-	-	ALL
60BA	0	Touch probe 1 rising edge capture position	Command unit	-	-	-	ALL
60BB	0	Touch probe 1 falling edge capture position	Command unit	-	-	-	ALL
60BC	0	Touch probe 2 rising edge capture position	Command unit	-	-	-	ALL
60BD	0	Touch probe 2 falling edge capture position	Command unit	-	-	-	ALL
60C5	0	Protocol maximum acceleration	Command unit /s/s	100000000	1	2147483647	ALL
60C6	0	Protocol maximum deceleration	Command unit /s/s	100000000	1	2147483647	ALL
60D5	0	Touch probe 1 rising edge counter	-	-	-	-	ALL
60D6	0	Touch probe 1 falling edge counter	-	-	-	-	ALL
60D7	0	Touch probe 2 rising edge counter	-	-	-	-	ALL
60D8	0	Touch probe 2 falling edge counter	-	-	-	-	ALL
60E0	0	Positive torque limit	0.1%	3000	0	65535	ALL
60E1	0	Negative torque limit	0.1%	3000	0	65535	ALL
60F4	0	Actual following error	Command unit	-	-	-	pp/hm
60FA	0	Speed of position loop	Command unit /s	-	-	-	csp/pp/hm
60FC	0	Internal command position	Encoder unit	-	-	-	pp/hm
60FD	0	Status of input	-	-	-	-	ALL
60FE	1	Output valid	-	-	-	-	ALL
	2	Output enable	-	-	-	-	ALL
60FF	0	Target speed (Restricted by 6080)	Command unit /s	0	-2147483648	2147483647	pv
6502	0	Supported operation mode	-	-	-	-	ALL

4.2 Parameters Function

Here is the explanation of parameters, you can check them or modify the value using configuration software or the front panel of drive.

Contact tech@leadshine.com if you need more technical service .

4.2.1 【Class 0】 Basic Setting

Pr0.00	Name	Mode loop gain			Mode						F
	Range	0~2000	Unit	0.1Hz	Default	0	Index			2000h	
Set up the bandwidth of MFC , it is similar to the response bandwidth											
Setup value		Description									
0		Disable the function.									
1		Enable the function, set the bandwidth automatically , recommended for most application .									
2-10		Forbidden and reserved.									

11-20000	Set the bandwidth manually , 1.1Hz – 2000Hz
----------	---

MFC is used to enhance the performance of dynamic tracing for input command , make positioning faster , cut down the tracking error , run more smooth and steady . It is very useful for multi-axis synchronous movement and interpolation, the performance will be better.

The main way to use this function :

- a. Choose the right control mode : Pr0.01 = 0
- b. Set up the inertia of ratio : Pr0.04
- c. Set up the rigidity : Pr0.03
- d. Set up the Pr0.00 :
 - 1) If no multi-axis synchronous movement , set Pr0.00 as 1 or more than 10 ;
 - 2) If multi-axis synchronous movement needed , set Pr0.00 as the same for all the axes .
 - 3) If Pr0.00 is more than 10 , start with 100 , or 150 , 200 , 250 ,

Caution:

1. Set up the right control mode , the right inertia of ratio and rigidity firstly .
2. Don't change the value of Pr0.00 when the motor is running , otherwise vibration occurs
Set up a small value from the beginning if using it in manual mode , smaller value means running more smooth and steady , while bigger one means faster positioning

Pr0.01	Name	Control Mode Setup			Mode							F
	Range	0~9	Unit	—	Default	9	Index	2001h				
Set using control mode:												
		Setup value	Content	Details								
		8	CANopen	PP/PV/PT/HM								
Note: valid after restart power supply.												

Pr0.02	Name	Real-time Auto-gain Tuning			Mode							F
	Range	0~2	Unit	—	Default	0	Index	2002h				
You can set up the action mode of the real-time auto-gain tuning.												
		Setup value	Mode	Varying degree of load inertia in motion								
		0	invalid	Real-time auto-gain tuning function is disabled.								
		1	standard	Basic mode. do not use unbalanced load, friction compensation or gain switching. It is usually for interpolation movement.								
		2	positioning	Main application is positioning. it is recommended to use this mode on equipment without unbalanced horizontal axis, ball screw driving equipment with low friction, etc. it is usually for point-to point movement .								
<p>Caution: If Pr0.02=1 or 2 , you can't modify the values of Pr1.01 – Pr1.13, the values of them depend on the real-time auto-gain tuning ,all of them are set by the drive itself.</p> <p>For Standard mode (Pr0.02=1), it is usually for interpolation movement. It is unavailable to modify the value of Pr1.00- 1.14, just need to change the value of Pr0.03 , then all values of Pr1.00-1.14 will be changed accordingly .</p> <p>For Positioning mode (Pr0.02=2), it is usually for point to point movement. It is unavailable to modify the value of Pr1.00- 1.14, just change the value of Pr0.03 ,then all values of Pr1.00-1.14 will be changed</p>												

Pr0.03	Name	Selection of machine stiffness at real- time auto-gain tuning			Mode							F
	Range	50 ~ 81	Unit	—	Default	70	Index	2003h				

You can set up response while the real-time auto-gain tuning is valid.

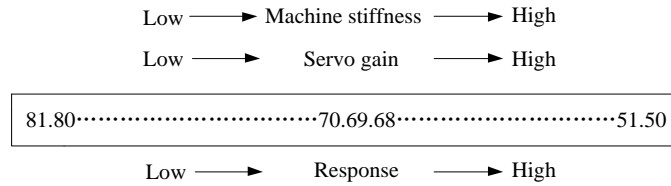

Notice: Lower the setup value, higher the velocity response and servo stiffness will be obtained. However, when decreasing the value, check the resulting operation to avoid oscillation or vibration.

Control gain is updated while the motor is stopped. If the motor can't be stopped due to excessively low gain or continuous application of one-way direction command, any change made to Pr0.03 is not used for update. If the changed stiffness setting is made valid after the motor stopped, abnormal sound or oscillation will be generated. To prevent this problem, stop the motor after changing the stiffness setting and check that the changed setting is enabled.

Pr0.04	Name	Inertia ratio			Mode						F
	Range	0~10000	Unit	%	Default	250	Index	2004h			
You can set up the ratio of the load inertia against the rotor(of the motor)inertia. $\text{Pr0.04} = (\text{load inertia} / \text{rotate inertia}) \times 100\%$											
<p>Notice:</p> If the inertia ratio is correctly set, the setup unit of Pr1.01 and Pr1.06 becomes (Hz). When the inertia ratio of Pr0.04 is larger than the actual value, the setup unit of the velocity loop gain becomes larger, and when the inertia ratio of Pr0.04 is smaller than the actual value, the setup unit of the velocity loop gain becomes smaller.											

Pr0.13	Name	1st Torque Limit			Mode						F
	Range	0~500	Unit	%	Default	300	Index	2013h			
You can set up the limit value of the motor output torque, as motor rate current %, the value can't exceed the maximum of output current. Compared with the maximum torque 6072, the actual torque limit value is smaller one.											

Pr0.14	Name	Position Deviation Excess Setup			Mode	PP			HM		
	Range	0~500	Unit	0.1rev	Default	200	Index	2014h			
Set excess range of positional deviation by the command unit(default).Setting the value too small will cause Err180 (position deviation excess detection)											

Pr0.15	Name	Absolute Encoder Setup			Mode	PP			HM		
	Range	0~15	Unit	-	Default	0	Index	2015h			

0: Incremental position mode:

The encoder is used as a incremental encoder, and the position retentive at power failure is not supported.

1: Absolute position linear mode:

The encoder is used as an absolute encoder, and the position retentive at power failure is supported.. It is applicable to the scenario where the travel range of device load is fixed and the encoder multi-turn data dose not overflow.

2: Absolute position rotation mode:

The encoder is used as an absolute encoder, and the position retentive at power failure is supported.. It is mainly applicable to the scenario where the load travel range is not limited and the number of motor single-direction revolution is less than 0~(Pr6.63+1)

5: Clean multi-turn alarm, and open multi-turn absolute function.

It will become 1 when normal clearance, if it's still 5 after 3seconds, please deal with according to 153 alarm processing.

9: Clear multi-turn position and reset multi-turn alarm, open multi-turn absolute function.

It will become 1 when normal clearance, if it's still 9 after 3seconds, please deal with according to 153 alarm processing. Please remember to do mechanical homing.

Notes: Set to 9 after homing process finished and servo disabled, valid after restart power-supply

Pr0.16	Name	External regenerative resistance value			Mode							F
	Range	40~500	Unit	Ohm	Default	100	Index	2016h				
Set Pr.0.16 and Pr.0.17 to confirm the threshold value of the discharge loop to give alarm for over current.												

Pr0.17	Name	External regenerative resistance power value			Mode							F
	Range	20~5000	Unit	W	Default	20	Index	2017h				
Set Pr.0.16 and Pr.0.17 to confirm the threshold value of the discharge loop to give alarm for over current.												

Pr0.23 *	Name	CAN Node ID			Mode							F
	Range	0~32767	Unit	—	Default	2	Index	2023h				
Setup the Node-ID of the slave station.												

Pr0.24 *	Name	CAN Baud rate			Mode							F
	Range	0~7	Unit	—	Default	0	Index	2024h				

Pr0.24	CAN baud rate (KHz)	Pr0.24	CAN baud rate (KHz)
0	1000	4	125
1	800	5	100
2	500	6	50
3	250	7	20

Pr0.25	Name	Synchronous compensation time 1			Mode							
	Range	1~100	Unit	0.1us	Default	10	Index	2025h				
Synchronous jitter compensation range, used in poor synchronization of the master station. Note: Valid after restart power.												

Pr0.26	Name	Synchronous compensation time 2			Mode						
	Range	1~2000	Unit	0.1us	Default	50	Index	2026h			

Synchronous jitter compensation range, used in poor synchronization of the master station.
Note: Valid after restart power.

4.2.2 【Class 1】 Gain Adjust

Pr1.00	Name	1st gain of position loop			Mode	PP		HM			
	Range	0~30000	Unit	0.1/s	Default	320	Index	2100h			

You can determine the response of the positional control system. Higher the gain of position loop you set, faster the positioning time you can obtain. Note that too high setup may cause oscillation.

Pr1.01	Name	1st gain of velocity loop			Mode						F
	Range	1~32767	Unit	0.1Hz	Default	180	Index	2101h			

You can determine the response of the velocity loop. In order to increase the response of overall servo system by setting high position loop gain, you need higher setup of this velocity loop gain as well. However, too high setup may cause oscillation.

Pr1.02	Name	1st Time Constant of Velocity Loop Integration			Mode						F
	Range	1~10000	Unit	0.1ms	Default	310	Index	2102h			

You can set up the integration time constant of velocity loop, Smaller the setup value, faster you can dog-in deviation at stall to 0. The integration will be maintained by setting to "9999". The integration effect will be lost by setting to "10000".

Pr1.03	Name	1st Filter of Velocity Detection			Mode						F
	Range	50~81	Unit	—	Default	70	Index	2103h			

You can set up the time constant of the low pass filter (LPF) after the speed detection, in 32 steps (50 to 81). Higher the setup, larger the time constant you can obtain so that you can decrease the motor noise, however, response becomes slow.

You can set the filter parameters through the loop gain, referring to the following table:

Setup Value	Speed Detection Filter Cut-off Frequency(Hz)	Setup Value	Speed Detection Filter Cut-off Frequency(Hz)
81	2500	65	750
80	2250	64	700
79	2100	63	650
78	2000	62	600
77	1800	61	550
76	1600	60	500
75	1500	59	450
74	1400	58	400
73	1300	57	350
72	1200	56	300
71	1100	55	250
70	1000	54	200

	69	950		53	175						
	68	900		52	150						
	67	850		51	125						
	66	800		50	100						

Pr1.04	Name	1st torque filter			Mode							F
	Range	0~2500	Unit	0.01ms	Default	126	Index	2104h				
Set the time constant of the first order hysteresis filter for the insertion of torque instruction. Vibration due to torsional resonance can be controlled.												

Pr1.05	Name	2nd gain of position loop			Mode	PP		HM				
	Range	0~30000	Unit	0.1/s	Default	380	Index	2105h				

Pr1.06	Name	2nd gain of velocity loop			Mode							F
	Range	1~32767	Unit	0.1Hz	Default	180	Index	2106h				

Pr1.07	Name	2nd Time Constant of Velocity Loop Integration			Mode							F
	Range	1~10000	Unit	0.1ms	Default	10000	Index	2107h				

Pr1.08	Name	2nd Filter of Velocity Detection			Mode							F
	Range	0~31	Unit	—	Default	15	Index	2108h				

Pr1.09	Name	2nd Time Constant of torque filter			Mode							F
	Range	0~2500	Unit	0.01ms	Default	126	Index	2109h				
Position loop, velocity loop, velocity detection filter, torque command filter have their 2 pairs of gain or time constant(1st and 2nd).												

Pr1.10	Name	Velocity feed forward gain			Mode	PP		HM				
	Range	0~1000	Unit	0.10%	Default	300	Index	2110h				
Multiply the velocity control command calculated according to the internal positional command by the ratio of this parameter and add the result to the speed command resulting from the positional control process.												

Pr1.11	Name	Velocity feed forward filter			Mode	PP		HM				
	Range	0~6400	Unit	0.01ms	Default	50	Index	2111h				

Set the time constant of 1st delay filter which affects the input of speed feed forward.

(usage example of velocity feed forward)

The velocity feed forward will become effective as the velocity feed forward gain is gradually increased with the speed feed forward filter set at approx.50 (0.5ms). The positional deviation during operation at a constant speed is reduced as shown in the equation below in proportion to the value of velocity feed forward gain.

$$\text{Position deviation [unit of command]} = \text{command speed [unit of command /s]} / \text{position loop gain[1/s]} \times (100 - \text{speed feed forward gain}[\%]) / 100$$

Pr1.12	Name	Torque feed forward gain		Mode	PP	PV	HM			
	Range	0~1000	Unit	0.1%	Default	0	Index	2112h		

- Multiply the torque control command calculated according to the velocity control command by the ratio of this parameter and add the result to the torque command resulting from the velocity control process.
- To use torque feed forward, correctly set ratio of inertia. Set the inertia ratio that can be calculated from the machine specification to Pr0.04 inertia ratio.
- Positional deviation at a constant acceleration/deceleration can be minimized close to 0 by increasing the torque forward gain .this means that positional deviation can be maintained at near 0 over entire operation range while driving in trapezoidal speed pattern under ideal condition where disturbance torque is not active.

Pr1.13	Name	Torque feed forward filter		Mode	PP	PV	HM			
	Range	0~6400	Unit	0.01ms	Default	0	Index	2113h		

Set up the time constant of 1st delay filter which affects the input of torque feed forward. zero positional deviation is impossible in actual situation because of disturbance torque. as with the velocity feed forward, large torque feed forward filter time constant decreases the operating noise but increases positional deviation at acceleration change point.

Pr1.15	Name	Mode of position control switching		Mode							F
	Range	0~10	Unit	—	Default	0	Index	2115h			

Setup value	Switching condition	Gain switching condition
0	Fixed to 1st gain	Fixed to the 1st gain (Pr1.00-Pr1.04)
1	Fixed to 2nd gain	Fixed to the 2nd gain (Pr1.05-Pr1.09)
2	Reserved	
3	Torque command is large	<ul style="list-style-type: none"> ● Shift to the 2nd gain when the absolute value of the torque command exceeded (level + hysteresis)[%]previously with the 1st gain. ● Return to the 1st gain when the absolute value of the torque command was kept below (level + hysteresis) [%]previously during delay time with the 2nd gain.
4	Reserved	Reserved
5	Speed command is large	<ul style="list-style-type: none"> ● Valid for position and speed controls. ● Shift to the 2nd gain when the absolute value of the speed command exceeded (level + hysteresis)[r/min]previously with the 1st gain. ● Return to the 1st gain when the absolute value of the speed command was kept below (level + hysteresis) [r/min] previously during delay time with the 2nd gain.

6	Position deviation is large	<ul style="list-style-type: none"> ● Valid for position control. ● Shift to the 2nd gain when the absolute value of the positional deviation exceeded (level + hysteresis)[pulse] previously with the 1st gain. ● Return to the 1st gain when the absolute value of the positional deviation was kept below (level + hysteresis)[r/min]previously during delay time with the 2nd gain. ◇ Unit of level and hysteresis [pulse] is set as the encoder resolution for positional control.
7	position command exists	<ul style="list-style-type: none"> ● Valid for position control. ● Shift to the 2nd gain when the positional command was not 0 previously with the 1st gain. ● Return to the 1st gain when the positional command was kept 0 previously during delay time with the 2nd gain.
8	Not in positioning complete	<ul style="list-style-type: none"> ● Valid for position control. ● Shift to the 2nd gain when the positioning was not completed previously with the 1st gain. ● Return to the 1st gain when the positioning was kept in completed condition previously during delay time with the 2nd gain.
9	Actual speed is large	<ul style="list-style-type: none"> ● Valid for position control. ● Shift to the 2nd gain when the absolute value of the actual speed exceeded (level + hysteresis) (r/min) previously with the 1st gain. ● Return to the 1st gain when the absolute value of the actual speed was kept below (level - hysteresis) (r/min) previously during delay time with the 2nd gain.
10	Have position command +actual speed	<ul style="list-style-type: none"> ● Valid for position control. ● Shift to the 2nd gain when the positional command was not 0 previously with the 1st gain. ● Return to the 1st gain when the positional command was kept at 0 during the delay time and the absolute value of actual speed was kept below (level - hysteresis) (r/min) previously with the 2nd gain.

In position control mode, setup Pr1.15=3,5,6,9,10;

In speed control mode, setup Pr1.15=3,5,9;

Pr1.17	Name	Level of position control switching			Mode							F
	Range	0~20000	Unit	Mode specific	Default	50	Index	2117h				
Unit of setting varies with switching mode. switching condition: position :encoder pulse number ; speed : r/min ; torque : % . Notice: set the level equal to or higher than the hysteresis.												

Pr1.18	Name	Hysteresis at position control switching			Mode							F
	Range	0~20000	Unit	Mode specific	Default	33	Index	2118h				
Combining Pr1.17(control switching level)setup Notice: when level< hysteresis, the hysteresis is internally adjusted so that it is equal to level.												

Pr1.19	Name	position gain switching time	Mode									F
---------------	------	------------------------------	------	--	--	--	--	--	--	--	--	----------

Range	0~10000	Unit	0.1ms	Default	33	Index	2119h
-------	---------	------	-------	---------	----	-------	-------

For position controlling: if the difference between 1st gain and 2nd gain is large, the increasing rate of position loop gain can be limited by this parameter.

<Position gain switching time>

Notice: when using position control, position loop gain rapidly changes, causing torque change and vibration. By adjusting Pr1.19 position gain switching time, increasing rate of the position loop gain can be decreased and variation level can be reduced.

Example: 1st (Pr1.00) <-> 2nd (Pr1.05)

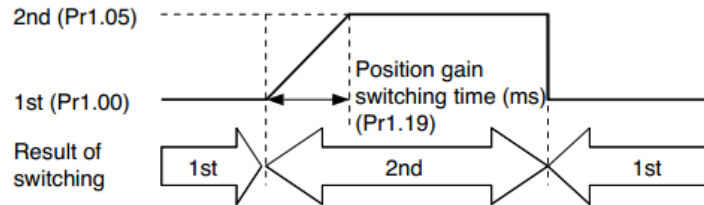

Pr1.37	Name	Special register			Mode							F
	Range	0~0xFFFF	Unit	-	Default	0	Index	2137h				

Bit	Pr1.37	Details	Bit	Pr1.37	Details
0	0x0001	shield the speed out of control alarm (1A1)	7	0x0080	shield the Resistance discharge circuit over-load error (120)
1	0x0002	shield the over-speed alarm (1A0)	8	0x0100	Reserved
2	0x0004	Enable virtual IO in homing mode	9	0x0200	shield UVW wire break alarm (0A3)
3	0x0008	Reserved	10	0x0400	Reserved
4	0x0010	shield the motor over-load error (100)	11	0x0800	shield Over-current alarm (0E0)
5	0x0020	Torque limit signal output threshold selection in torque mode: shield 6071	12	Reserved	
6	0x0040	shield the motor vibration error (190)	13	Reserved	

4.2.3 【Class 2】 Vibration Suppression

Pr2.00	Name	Adaptive filter mode setup			Mode							F
	Range	0~4	Unit	-	Default	0	Index	2200h				

Set up the resonance frequency to be estimated by the adaptive filter and the special the operation after estimation.

Setup value	Details	
0	Adaptive filter: invalid	Parameters related to the 3rd and 4th notch filter hold the current value.
1	Adaptive filter, 1 filter is valid, one time	One adaptive filter is valid, parameters related to the 3rd notch filter will be updated based on adaptive performance. After updated, Pr2.00 returns to 0, stop self-adaptation.
2	Adaptive filter, 1 filter is valid, It will be valid all the time	One adaptive filter is valid, parameters related to the 3rd notch filter will be updated all the time based on adaptive performance.

3-4	Not use	Non-professional forbidden to use
-----	---------	-----------------------------------

Pr2.01	Name	1st notch frequency			Mode							F
	Range	50~2000	Unit	Hz	Default	2000	Index	2201h				
Set the center frequency of the 1st notch filter Notice: the notch filter function will be invalidated by setting up this parameter to “2000”.												

Pr2.02	Name	1st notch width selection			Mode							F
	Range	0~20	Unit	-	Default	2	Index	2202h				
Set the width of notch at the center frequency of the 1st notch filter. Notice: Higher the setup, larger the notch width you can obtain. Use with default setup in normal operation.												

Pr2.03	Name	1st notch depth selection			Mode							F
	Range	0~99	Unit	-	Default	0	Index	2203h				
Set the depth of notch at the center frequency of the 1st notch filter. Notice: Higher the setup, shallower the notch depth and smaller the phase delay you can obtain.												

Pr2.04	Name	2nd notch frequency			Mode							F
	Range	50~2000	Unit	Hz	Default	2000	Index	2204h				
Set the center frequency of the 2nd notch filter Notice: the notch filter function will be invalidated by setting up this parameter to “2000”.												

Pr2.05	Name	2nd notch width selection			Mode							F
	Range	0~20	Unit	-	Default	2	Index	2205h				
Set the width of notch at the center frequency of the 2nd notch filter. Notice: Higher the setup, larger the notch width you can obtain. Use with default setup in normal operation.												

Pr2.06	Name	2nd notch depth selection			Mode							F
	Range	0~99	Unit	-	Default	0	Index	2206h				
Set the depth of notch at the center frequency of the 2nd notch filter. Notice: Higher the setup, shallower the notch depth and smaller the phase delay you can obtain.												

Pr2.07	Name	3rd notch frequency			Mode							F
	Range	50~2000	Unit	Hz	Default	2000	Index	2207h				
Set the center frequency of the 3rd notch filter Notice: the notch filter function will be invalidated by setting up this parameter to “2000”. Setup invalid after opening self-adaptation function.												

Pr2.14	Name	1st damping frequency			Mode							F
---------------	------	-----------------------	--	--	------	--	--	--	--	--	--	----------

	Range	10~2000	Unit	0.1Hz	Default	0	Index	2214h
0: close Setup damping frequency, to suppress vibration at the load edge.								

Pr2.15	Name	2nd damping frequency			Mode						F
	Range	10~2000	Unit	0.1Hz	Default	0	Index	2215h			
0: close Setup damping frequency, to suppress vibration at the load edge.											

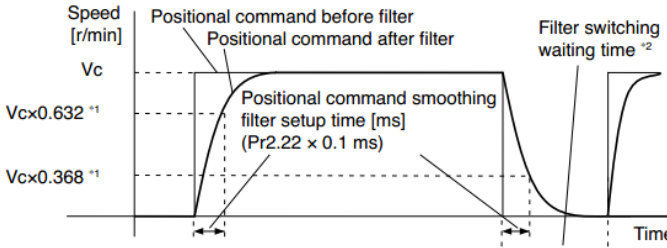
Pr2.22	Name	positional command smoothing filter			Mode	PP		HM			
	Range	0~32767	Unit	0.1ms	Default	0	Index	2222h			
<ul style="list-style-type: none"> ● Set up the time constant of the 1st delay filter in response to the positional command. ● When a square wave command for the target speed V_c is applied, set up the time constant of the 1st delay filter as shown in the figure below. 											
											

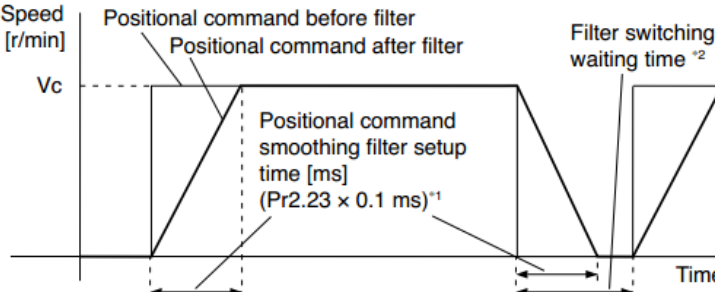
Pr2.23	Name	positional command FIR filter			Mode	PP		HM			
	Range	0~10000	Unit	0.1ms	Default	0	Index	2223h			
<ul style="list-style-type: none"> ● Set up the time constant of the 1st delay filter in response to the positional command. ● When a square wave command for the target speed V_c is applied, set up the V_c arrival time as shown in the figure below. 											
											

4.2.4 【Class 3】 Velocity/ Torque Control

Pr3.12	Name	time setup acceleration			Mode		PV				
	Range	0~10000	Unit	Ms/ (1000RPM)	Default	100	Index	2312h			
Pr3.13	Name	time setup deceleration			Mode		PV				

	Range	0~10000	Unit	Ms/ (1000RPM)	Default	100	Index	2313h
--	-------	---------	------	------------------	---------	-----	-------	-------

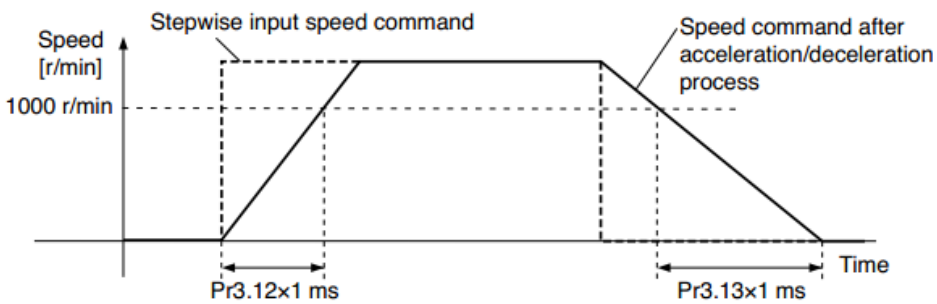

Set up acceleration/deceleration processing time in response to the speed command input.
 Set the time required for the speed command(stepwise input)to reach 1000r/min to Pr3.12
 Acceleration time setup. Also set the time required for the speed command to reach from 1000r/min to
 0 r/min, to Pr3.13 Deceleration time setup.
 Assuming that the target value of the speed command is Vc(r/min), the time required for acceleration
 /deceleration can be computed from the formula shown below.
 Acceleration time (ms)=Vc/1000 *Pr3.12 *1ms
 Deceleration time (ms)=Vc/1000 *Pr3.13 *1ms

Pr3.14	Name	Sigmoid acceleration/deceleration time setup			Mode		PV				
	Range	0~1000	Unit	ms	Default	0	Index	2314h			

Set S-curve time for acceleration/deceleration process when the speed command is applied. According to
 Pr3.12 Acceleration time setup and Pr3.13 Deceleration time setup, set up sigmoid time with time width
 centering the inflection point of acceleration/deceleration.

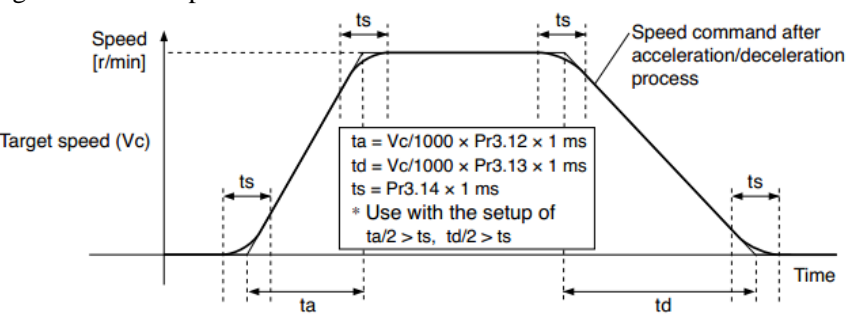

$$t_a = V_c/1000 \times Pr3.12 \times 1 \text{ ms}$$

$$t_d = V_c/1000 \times Pr3.13 \times 1 \text{ ms}$$

$$t_s = Pr3.14 \times 1 \text{ ms}$$

* Use with the setup of $t_a/2 > t_s, t_d/2 > t_s$

4.2.5 【Class 4】 I/F Monitor Setting

Pr4.02	Name	Input selection DI3			Mode						F
	Range	0~00FFFFFFh	Unit	—	Default	0x14	Index	2402h			
Pr4.03	Name	Input selection DI4			Mode						F
	Range	0~00FFFFFFh	Unit	—	Default	0x16	Index	2403h			
Pr4.04	Name	Input selection DI5			Mode						F
	Range	0~00FFFFFFh	Unit	—	Default	0x01	Index	2404h			
Pr4.05	Name	Input selection DI6			Mode						F
	Range	0~00FFFFFFh	Unit	—	Default	0x02	Index	2405h			

Assign functions to digital inputs.

This parameter use 16 binary system to set up the values,

For the function number, please refer to the following table.

Signal	Symbol	Setup value		0x60FD(bit)
		Normally open	Normally closed	
Invalid	—	00h	Do not setup	×
Positive direction over-travel inhibition input	POT	01h	81h	1
Negative direction over-travel inhibition input	NOT	02h	82h	0
Alarm clear input	A-CLR	04h	Do not setup	
Forced alarm input	E-STOP	14h	94h	
HOME-SWITCH	HOME-SWITCH	16h	96h	2

- Normally open means input signal comes from external controller or component, for example: PLC .
- Normally closed means input signal comes from drive internally.
- Don't setup to a value other than that specified in the table .
- Don't assign specific function to 2 or more signals. Duplicated assignment will cause Err210 I/F input multiple assignment error 1or Err211 I/F input multiple assignment error 2.
- E-STOP: Associated parameter Pr4.43

Pr4.10	Name	Output selection DO1			Mode						F
	Range	0~00FFFFFFh	Unit	—	Default	0x81	Index			2410h	
Pr4.11	Name	Output selection DO2			Mode						F
	Range	0~00FFFFFFh	Unit	—	Default	0x02	Index			2411h	

Assign functions to digital outputs.

This parameter use 16 binary system do setup

For the function number, please refer to the following table.

Signal name	Symbol	Setup Value	
		Normally open	Normally closed
Master control output	—	00h	Do not setup
Alarm output	Alm	81h	01h
Servo-Ready output	S-RDY	02h	82h
Eternal brake release signal	BRK-OFF	03h	83h
Positioning complete output	INP	04h	84h
At-speed output	AT-SPPED	05h	85h
Torque limit signal output	TLC	06h	86h
Zero speed clamp detection output	ZSP	07h	87h
Velocity coincidence output	V-COIN	08h	88h
Positional command ON/OFF output	P-CMD	0Bh	8Bh
Speed limit signal output	V-LIMIT	0Dh	8Dh
Speed command ON/OFF output	V-CMD	0Fh	8Fh
Servo enable state output	SRV-ST	12h	92h
Homing process finish	HOME-OK	22h	A2h

- Normally open: Active low
- Normally closed: Active high
- Don't setup to a value other than that specified in the table .
- Pr4.10~Pr4.11 correspond to DO1~DO2 respectively.

Pr4.31	Name	Positioning complete range			Mode	PP		HM		
	Range	0~10000	Unit		Default	10	Index	2431h		

Setup the timing of positional deviation at which the positioning complete signal (INP1) is output.

Pr4.32	Name	Positioning complete output setup			Mode	PP		HM		
	Range	0~4	Unit	-	Default	0	Index	2432h		

Select the condition to output the positioning complete signal (INP1).

Setup value	Action of positioning complete signal
0	The signal will turn on when the positional deviation is smaller than Pr4.31 [positioning complete range].
1	The signal will turn on when there is no position command and position deviation is smaller than Pr4.31 [positioning complete range].
2	The signal will turn on when there is no position command, the zero-speed detection signal is ON and the positional deviation is smaller than Pr4.31 [positioning complete range].
3	The signal will turn on when there is no position command and the positional deviation is smaller than Pr4.31 [positioning complete range]. Then holds "ON" states until the next position command is entered. Subsequently, ON state is maintained until Pr4.33 INP hold time has elapsed. After the hold time, INP output will be turned ON/OFF according to the coming positional command or condition of the positional deviation.
4	When there is no command, the position determination starts after the delay time set by Pr4.33. The signal will turn on when there is no position command and positional deviation is smaller than Pr4.31 [positioning complete range]

Pr4.33	Name	INP hold time			Mode	PP		HM		
	Range	0~15000	Unit	1 ms	Default	0	Index	2433h		

Set up the hold time when Pr 4.32 positioning complete output setup=3.

Setup value	State of Positioning complete signal
0	The hold time is maintained definitely, keeping ON state until next positional command is received.
1-15000	ON state is maintained for setup time (ms) but switched to OFF state as the positional command is received during hold time.

Pr4.34	Name	Zero-speed			Mode					F
	Range	10~2000	Unit	RPM	Default	50	Index	2434h		

The rotation speed (RPM) was used to set the output timing sequence of the zero speed detection output signal (ZSP). When the motor speed is lower than the setting speed of this parameter, zero speed detection signal (ZSP) is output.

You can set up the timing to feed out the zero-speed detection output signal(ZSP or TCL) in rotate speed (r/min). The zero-speed detection signal(ZSP) will be fed out when the motor speed falls below the setup of this parameter, Pr4.34

- the setup of pr4.34 is valid for both positive and negative direction regardless of the motor rotating direction.
- There is hysteresis of 10[r/min].

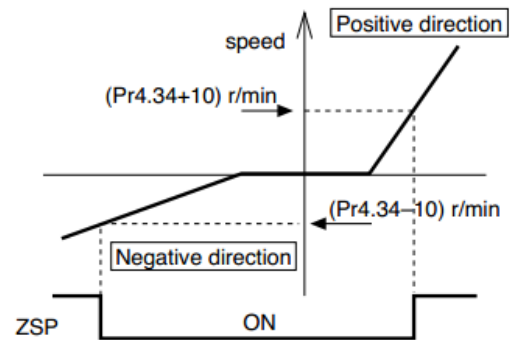

Pr4.35	Name	Speed coincidence range			Mode	PV			
	Range	10~2000	Unit	RPM	Default	50	Index	2435h	

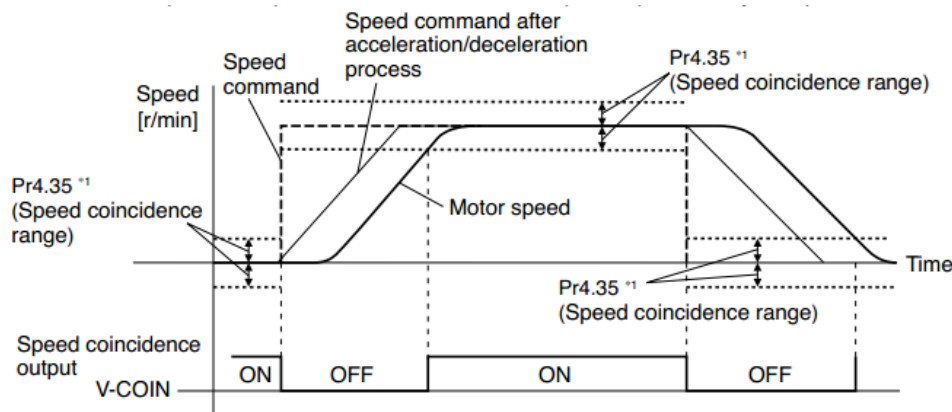

Set the speed coincidence (V-COIN) output detection timing.

Output the speed coincidence (V-COIN) when the difference between the speed command and the motor speed is equal to or smaller than the speed specified by this parameter.

Because the speed coincidence detection is associated with 10 r/min hysteresis, actual detection range is as shown below.

Speed coincidence output OFF -> ON timing $(Pr4.35 - 10)$ r/min

Speed coincidence output ON -> OFF timing $(Pr4.35 + 10)$ r/min

Pr4.36	Name	At-speed(Speed arrival)			Mode	PV			
	Range	10~2000	Unit	RPM	Default	1000	Index	2436h	

Set the detection timing of the speed arrival output (AT-SPEED).
 When the motor speed exceeds this setup value, the speed arrive output (AT-SPEED) is output.
 Detection is associated with 10r/min hysteresis .

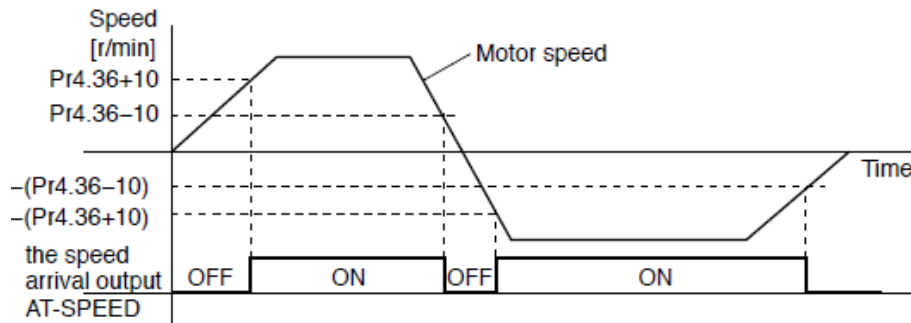

Pr4.37	Name	Mechanical brake action at stalling setup			Mode															F
	Range	0~10000	Unit	1ms	Default	0	Index	2437h												

Motor brake delay time setup, mainly used to prevent servo on “galloping” phenomenon.
 Set up the time from when the brake release signal(BRK-OFF) turns off to when the motor is de-energized (servo-free),when the motor turns to servo-off while the motor is at stall

- Set up to prevent a micro-travel/drop of the motor (work) due to the action delay time(t_b) of the brake.
- After setting up $Pr4.37 \geq t_b$, then compose the sequence so as the drive turns to servo-off after the brake is actually activated.

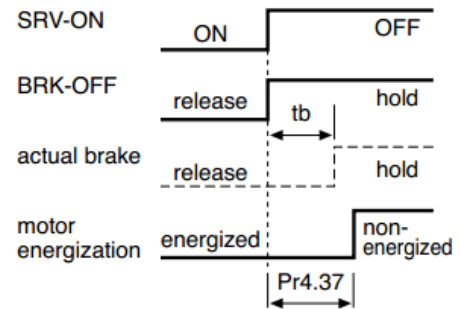

Pr4.38	Name	Mechanical brake action at running setup			Mode																F
	Range	0~10000	Unit	1ms	Default	0	Index	2438h													

Mechanical brake start delay time setup, mainly used to prevent servo off “galloping” phenomenon.
 Set up time from when detecting the off of servo-on input signal(SRV-ON)is to when external brake release signal(BRK-OFF)turns off, while the motor turns to servo off during the motor in motion.

- Set up to prevent the brake deterioration due to the motor running.
- At servo-OFF during the motor is running , t_b of the right fig will be a shorter one of either Pr4.38 setup time, or time lapse till the motor speed falls below Pr4.39 setup speed.

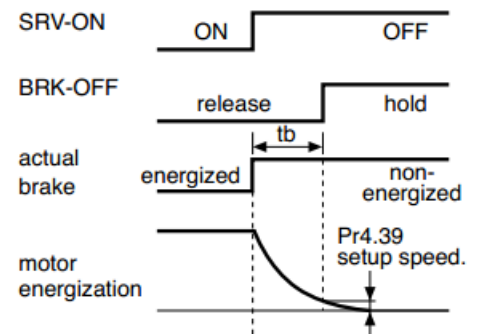

Pr4.39	Name	Brake release speed setup			Mode																F
	Range	30~3000	Unit	1ms	Default	30	Index	2439h													

Set up the speed timing of braking output checking during operation

Pr4.43	Name	E-stop function			Mode							F
	Range	0~1	Unit	-	Default	0	Index	2443h				
0: When E-STOP is effective, the servo will forced to STOP and servo-disabled, and alarm showing (Err570) . 1: When E-STOP is effective, the servo will forced to STOP and keep in servo-enable, no alarm showing.												

4.2.6 【Class 5】 Extended Setup

Pr5.04	Name	Over-travel inhibit input setup			Mode							F
	Range	0~2	Unit	—	Default	0	Index	2504h				
set to 1, no effect on homing mode.												
		Setup value	Details									
		0	positive and negative limit effective, no alarm output									
		1	positive and negative limit effective invalid									
		2	positive and negative limit effective, alarm Err26.0									
In homing mode, POT/NOT invalid Settings please set the object dictionary 5012-04 bit0=1												

Pr5.06	Name	Stop mode			Mode							F
	Range	0~1	Unit	—	Default	0	Index	2506h				
Specify the status during deceleration and after stop, after servo-off.												
		Setup value	Details									
		0	Disabled when disable signal effective and speed reduce to Pr4.39									
		1	Disabled when disable signal effective, free-run to stop									

Pr5.08	Name	LV trip selection at main power OFF			Mode							F
	Range	0~1	Unit	—	Default	1	Index	2508h				
You can select whether or not to activate Err0d.0 (main power under-voltage protection)function while the main shutoff continues for the setup of Pr5.09(The main power-OFF detection time).												
		Setup value	Action of main power low voltage protection									
		0	When the main power is shut off during Servo-On,Err0d.0 will not be triggered and the drive turns to Servo-OFF. The drive returns to Servo-On again after the main power resumption.									
		1	When the main power is shut off during Servo-On, the drive will trip due to Err0d.0									
Caution: Err0d.0(main power under-voltage protection) is trigged when setup of Pr5.09 is long and P-N voltage of the main converter falls below the specified value before detecting the main power shutoff , regardless of the Pr5.08 setup.												

Pr5.09	Name	The main power-OFF detection time			Mode							F
	Range	70~2000	Unit	ms	Default	70	Index	2509h				
You can set up the time to detect the shutoff while the main power is kept shut off continuously. The main power off detection is invalid when you set up this to 2000.												

Pr5.11	Name	Torque setup for emergency stop			Mode							F
	Range	0~500	Unit	%	Default	0	Index	2511h				

Set up the torque limit at emergency stop
 When setup value is 0, the torque limit for normal operation is applied.
 Compared with the maximum torque 6072, the actual torque limit value is smaller one.

Pr5.12	Name	Over-load level setup			Mode							F
	Range	0~115	Unit	%	Default	0	Index	2512h				

You can set up over-load level. The overload level becomes 115% by setting up this value to 0.
 Use this with 0 setup in normal operation, set up other value only when you need to low this over-load level.
 The setup value of this parameter is limited by 115% of the motor rating.

Pr5.13	Name	Over-speed level setup			Mode							F
	Range	0~10000	Unit	RPM	Default	0	Index	2513h				

If the motor speed exceeds this setup value, Err1A.0 [over-speed protect] occurs.
 The over-speed level becomes 1.2 times of the motor max, speed by setting up this to 0.

Pr5.20	Name	Position setup unit select			Mode							F
	Range	0~2	Unit	—	Default	2	Index	2520h				

Specify the unit to determine the range of positioning complete and excessive positional deviation

Setup value	unit
0	Encoder unit
1	Command unit
2	Standard 2500-line unit

Pr5.21	Name	Selection of torque limit			Mode							F
	Range	0~2	Unit	—	Default	0	Index	2521h				

Set up the torque limiting method;

Setup value	Positive limit value	Negative limit value
0	Pr0.13	Pr0.13
1	Pr0.13	Pr5.22
2	60E0	60E1

Compared with the maximum torque 6072, the actual torque limit value is smaller one

Pr5.22	Name	2nd torque limit			Mode							F
	Range	0~500	Unit	%	Default	300	Index	2522h				

Set up the 2nd limit value of the motor torque output
 The value of the parameter is limited to the maximum torque of the applicable motor.
 Compared with the maximum torque 6072, the actual torque limit value is smaller one

Pr5.28	Name	LED initial status			Mode							F
	Range	0~42	Unit	—	Default	34	Index	2528h				

You can select the type of data to be displayed on the front panel LED (7-segment) at the initial status after power-on.

Setup value	content	Setup value	content	Setup value	content
0	Positional command deviation	15	Over-load factor	30	Number of abnormal communication of encoder
1	Motor speed	16	Inertia ratio	31	Accumulated operation time
2	Positional command speed	17	Factor of no-motor running	32	Automatic motor identification
3	Velocity control command	18	No. of changes in I/O signals	33	Temperature information
4	Torque command	19	Number of overcurrent signals	34	Servo state
5	Feedback pulse sum	20	Absolute encoder data	35	/
6	Command pulse sum	21	Absolute external scale position	36	Synchronous period
7	Maximum torque during motion	22	Absolute multi-turn position	37	Synchronous loss time
8		23	Communication axis address	38	Synchronous type
9	Control mode	24	Encoder positional deviation[encoder unit]	39	Whether DC is running or not
10	I/O signal status	25	Motor electromechanical angle	40	ACC/DEC
11	/	26	Motor mechanical Angle	41	Sub-index of OD index
12	Error factor and reference of history	27	Voltage across PN	42	The value of sub-index of OD index
13	Alarm code	28	Software version		
14	Regenerative load factor	29			

Notes: Valid after restart the power.

Pr5.33	Name	Touch probe 1 signal compensation time			Mode													F
	Range	0~32767	Unit	25ns	Default	0	Index			2533h								
Time compensation for signal acquisition of touch probe 1 to provide more accurate capture position and prevent the instantaneous jitter of capture during master and slave cooperation																		

Pr5.34	Name	Touch probe 2 signal compensation time			Mode														F
	Range	0~32767	Unit	25ns	Default	0	Index			2534h									
Time compensation for signal acquisition of touch probe 2 to provide more accurate capture position and prevent the instantaneous jitter of capture during master and slave cooperation																			

Pr5.37	Name	Torque saturation alarm detection time			Mode														F
	Range	0~5000	Unit	ms	Default	500	Index			2537h									

When the duration of torque saturation reaches this value, the torque saturation signal will turn on.

- 1、 Enable the torque saturation alarm, this parameter can be set to specify the output time of the torque saturation signal
- 2、 Disable the torque saturation alarm, this parameter can be set to specify the output time after the torque limit arrives while the homing method is torque detection.

Pr5.39	Name	3rd torque limit			Mode							F
	Range	0~500	Unit	%	Default	80	Index	2539h				
Set the torque limit of torque limit detection homing method. Compared with the maximum torque 6072, the actual torque limit value is smaller one.												

4.2.7 【Class 6】 Special Setup

Pr6.01	Name	Encoder zero position compensation			Mode							F
	Range	0~360	Unit	°	Default	0	Index	2601h				
The Angle of the encoder after zero correction.												

Pr6.04	Name	JOG trial run command speed			Mode							F
	Range	0~10000	Unit	r/min	Default	300	Index	2604h				
You can set up the command speed used for JOG trial run (velocity control).												

Pr6.05	Name	Position 3rd gain valid time			Mode	PP			HM			
	Range	0~10000	Unit	0.1ms	Default	0	Index	2605h				
Set up the time at which 3 rd gain becomes valid. When not using this parameter, set PR6.05=0, PR6.06=100 This is valid for only position control/full-closed control.												
Pr6.06	Name	Position 3rd gain scale factor			Mode	PP			HM			
	Range	0~1000	Unit	100%	Default	100	Index	2606h				
Set up the 3 rd gain by multiplying factor of the 1 st gain 3rd gain= 1st gain * Pr6.06/100												

Pr6.07	Name	Torque command additional value			Mode							F
	Range	-100~100	Unit	%	Default	0	Index	2607h				
Pr6.08	Name	Positive direction torque compensation value			Mode							F
	Range	-100~100	Unit	%	Default	0	Index	2608h				
Pr6.09	Name	Negative direction torque compensation value			Mode							F
	Range	-100~100	Unit	%	Default	0	Index	2609h				

These three parameters may apply feed forward torque superposition directly to torque command.

Pr6.11	Name	Current response setup			Mode															F
	Range	50~100	Unit	%	Default	100	Index			2611h										
Set the effective value ratio of drive current loop related parameters.																				

Pr6.12	Name	Setting of torque limit for zero correction of encoder.			Mode															F
	Range	-300~300	Unit	%	Default	50	Index			2612h										
Setting of torque limit for zero correction of encoder.																				

Pr6.13	Name	2nd inertia ratio			Mode															F
	Range	0~10000	Unit	%	Default	0	Index			2613h										
Set up 2nd inertia ratio Set up the ratio of the load inertia against the rotor of the motor ratio. PR6.13= (load inertia/ rotor inertia) * 100 【 % 】																				

Pr6.14	Name	Emergency stop time at alarm			Mode															F
	Range	0~3000	Unit	ms	Default	200	Index			2614h										
Set up the time allowed to complete emergency stop in an alarm condition, exceeding this time puts this system in alarm state.																				

Pr6.20	Name	Trial run distance			Mode															F
	Range	0~1200	Unit	0.1rev	Default	10	Index			2620h										
The distance of running each time in JOG run(position control)																				

Pr6.21	Name	Trial run waiting time			Mode															F
	Range	0~30000	Unit	ms	Default	100	Index			2620h										
The waiting time after running each time in JOG run(position control)																				

Pr6.22	Name	Trial run cycle times			Mode															F
	Range	0~32767	Unit	—	Default	1	Index			2622h										
The cycling times of JOG run(position control)																				

Pr6.25	Name	Acceleration of trial running			Mode															F
	Range	0~32767	Unit	ms	Default	100	Index			2625h										
Acceleration of trial running																				

Pr6.26	Name	Mode of trial running			Mode								F
	Range	0~32767	Unit	—	Default	0	Index			2626h			
0: Normal trial run mode 1: Aging mode for manufacturers													

Pr6.34	Name	Frame error window time			Mode								F
	Range	0~32767	Unit	ms	Default	100	Index			2634h			
Set the CANopen data frame error alarm detection window time													

Pr6.35	Name	Frame error window			Mode								F
	Range	0~32767	Unit	ms	Default	50	Index			2635h			
Set the CANopen data frame error alarm detection window													

Pr6.61	Name	Z signal duration time			Mode								F
	Range	0~1000	Unit	ms	Default	10	Index			2661h			
Set the high level holding time of Z signal 1、 Z signal for 60FDH; 2、 Z signal for homing process													

Pr6.62	Name	Overload warning threshold			Mode								F
	Range	0~99	Unit	%	Default	0	Index			2662h			
Before an overload alarm, pre-alarm.													

Pr6.63	Name	upper limit of multi - turn absolute position			Mode								F
	Range	0~32766	Unit	r	Default	0	Index			2663h			
While Pr0.15=2, the feedback position will loop between 0 - (Pr6.63+1)*Encoder resolution													

4.2.8 【Class 7】 Factory setting

Pr7.31	Name	Regenerative resistance control mode setting			Mode		P	S	T								
	Range	0~2	Unit	--	Default	0											
<table border="1" style="width: 100%; border-collapse: collapse;"> <thead> <tr style="background-color: #008000; color: white;"> <th style="width: 20%;">Setup value</th> <th>Details</th> </tr> </thead> <tbody> <tr> <td style="text-align: center;">0</td> <td>Disable regenerative resistance discharge</td> </tr> <tr> <td style="text-align: center;">1</td> <td>Enable reactive pump lift suppression function</td> </tr> <tr> <td style="text-align: center;">2</td> <td>Enable regenerative resistance discharge</td> </tr> </tbody> </table>										Setup value	Details	0	Disable regenerative resistance discharge	1	Enable reactive pump lift suppression function	2	Enable regenerative resistance discharge
Setup value	Details																
0	Disable regenerative resistance discharge																
1	Enable reactive pump lift suppression function																
2	Enable regenerative resistance discharge																
Notice:																	

Pr7.32	Name	Regenerative resistance open threshold setting			Mode		P	S	T
	Range	20~90	Unit	V	Default	80			
The external resistance is activated when the actual bus voltage is higher than Pr7.32 plus Pr7.33 and is									

deactivated when the actual bus voltage is lower than Pr7.32 minus Pr7.33

Notice:

Pr7.33	Name	Regenerative resistance control hysteresis				Mode	P	S	T
	Range	1~50	Unit	V	Default	5			

The external resistance is activated when the actual bus voltage is higher than Pr7.32 plus Pr7.33 and is deactivated when the actual bus voltage is lower than Pr7.32 minus Pr7.33

Notice:

4.3 402 Parameters Function

Index 603FH	Name	Error code				-	Structure	VAR	Type	Uint 16
	Access	RO	Mapping	TPDO	Mode	ALL	Range	0-6553 5	Default	-

Index 6040H	Name	Control word				-	Structure	VAR	Type	Uint 16
	Access	RW	Mapping	RPDO	Mode	ALL	Range	0-6553 5	Default	0

Bit	15~11	10~9	8	7	6~4	3	2	1	0
Definition	-	-	Halt	Fault reset	Mode specific	Enable operation	Quick stop	Enable voltage	Switch on

Index 6041H	Name	Status word				-	Structure	VAR	Type	Uint 16
	Access	RO	Mapping	TPDO	Mode	ALL	Range	0-0XF FFF	Default	0

Bit	7	6	5	4	3	2	1	0
Definition	Reserved	Switch on disabled	Quick stop	Voltage output	Fault	Operation enable	Switch on	Ready to switch on
Bit	15	14	13	12	11	10	9	8
Definition	Reserved	Reserved	Mode specific	Mode specific	Position limit active	Target reached	Remote	Mode specific

Index 605AH	Name	Quick stop option code				-	Structure	VAR	Type	INT 16
	Access	RW	Mapping	-	Mode	ALL	Range	0-7	Default	0

PP, PV Mode

- 0 : Stop according to 3506h(Sequence at Servo-off), keeping Switch on disabled
- 1 : Stop according to 6084h(Profile deceleration), keeping Switch on disabled
- 2 : Stop according to 6085h(Quick stop deceleration), keeping Switch on disabled
- 3 : Stop according to 60C6h(Max deceleration), keeping Switch on disabled

- 5 : Stop according to 6084h(Profile deceleration), keeping Quick stop active
- 6 : Stop according to 6085h(Quick stop deceleration), keeping Quick stop active
- 7 : Stop according to 60C6h(Max deceleration), keeping Quick stop active

HM Mode

- 0 : Stop according to 3506h(Sequence at Servo-off), keeping Switch on disabled
- 1 : Stop according to 609Ah(Homing acceleration), keeping Switch on disabled
- 2 : Stop according to 6085h(Quick stop deceleration), keeping Switch on disabled
- 3 : Stop according to 60C6h(Max deceleration), keeping Switch on disabled
- 5 : Stop according to 609Ah(Homing acceleration), keeping Quick stop active
- 6 : Stop according to 6085h(Quick stop deceleration), keeping Quick stop active
- 7 : Stop according to 60C6h(Max deceleration), keeping Quick stop active

Index	Name	Halt option code					Structure	VAR	Type	INT 16
605DH	Access	RW	Mapping	-	Mode	ALL	Range	1-3	Default	1

PP, PV Mode

- 1 : Stop according to 6084h(Profile deceleration), keeping Operation enabled
- 2 : Stop according to 6085h(Quick stop deceleration), keeping Operation enabled
- 3 : Stop according to 6072h(Max torque)、60C6h(Max deceleration), Stop according to torque=0Operation enabled

HM Mode

- 1 : Stop according to 609Ah(Homing acceleration), keeping Operation enabled
- 2 : Stop according to 6085h(Quick stop deceleration), keeping Operation enabled
- 3 : Stop according to 6072h(Max torque)、60C6h(Max deceleration), keeping Operation enabled

Index	Name	Mode of operation					Structure	VAR	Type	int 8
6060H	Access	RW	Mapping	RPDO	Mode	ALL	Range	0-10	Default	0
		NO	Mode							
		1	Profile position mode			PP				
		3	Profile velocity mode			PV				
		4	profile Torque mode			PT				
		6	Homing mode			HM				

Index	Name	Mode of operation display					Structure	VAR	Type	int 8
6061H	Access	R0	Mapping	TPDO	Mode	ALL	Range	0-10	Default	0
		NO	Mode							
		1	Profile position mode			PP				
		3	Profile velocity mode			PV				
		4	profile Torque mode			PT				
		6	Homing mode			HM				

Index	Name	Actual internal position value					Structure	VAR	Type	Dint 32
					-					

6063H	Access	RO	Mapping	TPDO	Mode	ALL	Range	Encoder unit	Default	-
Actual internal position value, Encoder unit										

Index	Name	Actual feedback position value				-	Structure	VAR	Type	Dint 32
6064H	Access	RO	Mapping	TPDO	Mode	ALL	Range	Command unit	Default	-
Actual feedback position value, Command Unit. 6064h * gear ratio = 6063h										

Index	Name	Target position				-	Structure	VAR	Type	int 32
607AH	Access	RW	Mapping	RPDO	Mode	PP	Range	Command unit	Default	-
Target Position for PP Mode										

Index	Name	Motor rotation direction					Structure	VAR	Type	Uint 8																																																																																														
607EH	Access	RW	Mapping	RPDO	Mode	ALL	Range	00-F F	Default	0																																																																																														
<table border="1" style="width: 100%; border-collapse: collapse;"> <thead> <tr> <th colspan="2" style="background-color: #008000; color: white;">Mode</th> <th colspan="9" style="background-color: #008000; color: white;">Value</th> </tr> </thead> <tbody> <tr> <td rowspan="2">Position mode</td> <td>PP</td> <td colspan="9">0: Rotate in the same direction as the command</td> </tr> <tr> <td>HM</td> <td colspan="9">128: Rotate in the opposite direction as the command</td> </tr> <tr> <td rowspan="2">Velocity mode</td> <td rowspan="2">PV</td> <td colspan="9">0: Rotate in the same direction as the command</td> </tr> <tr> <td colspan="9">64: Rotate in the opposite direction as the command</td> </tr> <tr> <td rowspan="2">Torque mode</td> <td rowspan="2">PT</td> <td colspan="9">0: Rotate in the same direction as the command</td> </tr> <tr> <td colspan="9">32: Rotate in the opposite direction as the command</td> </tr> <tr> <td>ALL mode</td> <td></td> <td colspan="9">0: Rotate in the same direction as the command</td> </tr> <tr> <td></td> <td></td> <td colspan="9">224: Rotate in the opposite direction as the command</td> </tr> </tbody> </table>											Mode		Value									Position mode	PP	0: Rotate in the same direction as the command									HM	128: Rotate in the opposite direction as the command									Velocity mode	PV	0: Rotate in the same direction as the command									64: Rotate in the opposite direction as the command									Torque mode	PT	0: Rotate in the same direction as the command									32: Rotate in the opposite direction as the command									ALL mode		0: Rotate in the same direction as the command											224: Rotate in the opposite direction as the command								
Mode		Value																																																																																																						
Position mode	PP	0: Rotate in the same direction as the command																																																																																																						
	HM	128: Rotate in the opposite direction as the command																																																																																																						
Velocity mode	PV	0: Rotate in the same direction as the command																																																																																																						
		64: Rotate in the opposite direction as the command																																																																																																						
Torque mode	PT	0: Rotate in the same direction as the command																																																																																																						
		32: Rotate in the opposite direction as the command																																																																																																						
ALL mode		0: Rotate in the same direction as the command																																																																																																						
		224: Rotate in the opposite direction as the command																																																																																																						

Index	Name	Encoder resolution				-	Structure	VAR	Type	Dint 32
608FH-01	Access	RO	Mapping	TPDO	Mode	ALL	Range		Default	
Read motor encoder resolution										

Index	Name	Electronic gear molecule				-	Structure	VAR	Type	Dint 32
6091H-01	Access	RW	Mapping	RPDO	Mode	ALL	Range		Default	
Set the resolution of motor encoder										

Index	Name	Electronic gear denominator				-	Structure	VAR	Type	Dint 32
6091H-02	Access	RW	Mapping	RPDO	Mode	ALL	Range	Command unit	Default	-
Set the number of pulses required for one motor rotation.										

Index	Name	Number of pulses per rotation				-	Structure	VAR	Type	Dint 32
6092H-01	Access	RW	Mapping	RPDO	Mode	ALL	Range	Command unit	Default	-

If 6092h_01 is not equal to 608Fh(Position encoder resolution), then:

$$\text{Electronic gear ratio} = \text{Encoder resolution} / 6092h_01$$

If 6092h_01 is equal to 608Fh(Position encoder resolution), then:

$$\text{Electronic gear ratio} = 6091_01 / 6092h_01$$

Index 6098H	Name	Homing Method				Structure	VAR	Type	Unit 8	
	Access	RW	Mapping	RPDO	Mode	ALL	Range	0-35	Default	0
	Homing Method	Description								
	-6	Search the homing point with low speed negative direction, when the torque reached then stop immediately								
	-5	Search the homing point with low speed positive direction, when the torque reached then stop immediately								
	-4	Search the homing point with low speed negative direction, when the torque reached then change the motion direction, when the torque is gone then stop immediately								
	-3	Search the homing point with low speed positive direction, when the torque reached then change the motion direction, when the torque is gone then stop immediately								
	-2	Search the homing point with low speed negative direction, when the torque reached then reverse the direction, when the torque is gone and Z signal coming then stop immediately								
	-1	Search the homing point with low speed positive direction, when the torque reached then reverse the direction, when the torque is gone and Z signal coming then stop immediately								
	1	Search the homing point in negative direction, deceleration point is negative limit switch, homing point is motor Z signal, the negative limit switch falling edge must come before Z signal								
	2	Search the homing point in positive direction, deceleration point is positive limit switch, homing point is motor Z signal, the positive limit switch falling edge must come before Z signal								
	3	Search the homing point in positive direction, deceleration point is homing switch, homing point is motor Z signal, the falling edge on the same side of homing switch must come before Z signal								
	4	Search the homing point in negative direction, deceleration point is homing switch, homing point is motor Z signal, the rising edge on the same side of homing switch must come before Z signal								
	5	Search the homing point in negative direction, deceleration point is homing switch, homing point is motor Z signal, the falling edge on the same side of homing switch must come before Z signal								
	6	Search the homing point in positive direction, deceleration point is homing switch, homing point is motor Z signal, the rising edge on the same side of homing switch must come before Z signal								
	7	Search the homing point in positive direction, deceleration point is homing switch, homing point is motor Z signal, the falling edge on the same side of homing switch must come before Z signal								
	8	Search the homing point in positive direction, deceleration point is homing switch, homing point is motor Z signal, the rising edge on the same side of homing switch must come before Z signal								
	9	Search the homing point in positive direction, deceleration point is homing switch, homing point is motor Z signal, the rising edge on the other side of homing switch must come before Z signal								
	10	Search the homing point in positive direction, deceleration point is homing switch, homing point is motor Z signal, the falling edge on the other side of homing switch must come before Z signal								
	11	Search the homing point in negative direction, deceleration point is homing switch, homing point is motor Z signal, the falling edge on the same side of homing switch must come before Z signal								
	12	Search the homing point in negative direction, deceleration point is homing switch, homing								

	point is motor Z signal, the rising edge on the same side of homing switch must come before Z signal
13	Search the homing point in negative direction, deceleration point is homing switch, homing point is motor Z signal on the other side of homing switch, the rising edge on the other side of homing switch must come before Z signal
14	Search the homing point in negative direction, deceleration point is homing switch, homing point is motor Z signal on the other side of homing switch, the falling edge on the other side of homing switch must come before Z signal
15	
16	
17-32	Similar with 1-14, but the deceleration point coincides with the homing point
33	Search the homing point in negative direction, homing point is motor Z signal
34	Search the homing point in positive direction, homing point is motor Z signal
35	Set the current position as homing point

Index	Name	Status of digital input					Structure	VAR	Type	Dint 32
60FDH	Access	R0	Mapping	TPDO	Mode	ALL	Range	0-ffff	Default	

The bits of a 60FDh object are functionally defined as follow:

Bit31	Bit30	Bit29	Bit28	Bit27	Bit26	Bit25	Bit24
Z signal	Reserved	Reserved	Reserved	Touch Probe 2	Touch Probe 1	BRAKE	INP/V-COIN /TLC
Bit23	Bit22	Bit21	Bit20	Bit19	Bit18	Bit17	Bit16
E-STOP	Reserved	Reserved	Reserved	Reserved	Reserved	SI14	SI13
Bit15	Bit14	Bit13	Bit12	Bit11	Bit10	Bit9	Bit8
SI12	SI11	SI10	SI9	SI8	SI7	SI6	SI5
Bit7	Bit6	Bit5	Bit4	Bit3	Bit2	Bit1	Bit0
SI4	SI3	SI2	SI1	Reserved	HOME	POT	NOT

Index	Name	Output valid					Structure	VAR	Type	Uint 32
60FEH-01	Access	RW	Mapping	RPDO	Mode	ALL	Range	0-ffff	Default	0

The bits of a 60FEh object are functionally defined as follow:

Bit Sub-index	31~21	21	20	19	18	17	16	15~0
01h	Reserved	DO6 valid	DO5 valid	DO4 valid	DO3 valid	DO2 valid	DO1 valid	Reserved

Index	Name	Output enable					Structure	VAR	Type	Uint 32
60FEH-02	Access	RW	Mapping		Mode	ALL	Range	0-ffff	Default	0

The bits of a 60FEh object are functionally defined as follow:

Bit Sub-index	31~21	21	20	19	18	17	16	15~0
02h	Reserved	DO6 enable	DO5 enable	DO4 enable	DO3 enable	DO2 enable	DO1 enable	Reserved

Chapter 5 CANopen

5.1 CAN Interface

The CAN-bus (Controller Area Network-Bus) is a serial communication protocol developed by Bosch to exchange information between electronic control units on automobiles. This system makes possible to share a great amount of information between nodes and control units appended to the system, leading to a major reduction in both the number of sensors required and the quality of cables in the electrical installation.

The CANopen protocol is based in CAN specification, and its frame definition is such that one CAN frame is required for each CANopen message.

5.2 CANopen protocol

CANopen is the internationally standardized CAN-based higher-layer protocol for embedded control system, as developed and maintained by CiA members. The set of CANopen specifications comprise the application layer and communication profile, as well as application, device, and interface profiles. CANopen provides very flexible configuration capabilities, and for this reason CANopen networks are used in a very broad range of application fields, such as machine control, medical devices, off-road and rail vehicles, maritime electronics, building automation, power generation, etc.

The CANopen protocol defines basically two aspects of the communication protocol: how the communication should be formatted (CANopen frame), and what objects are defined in common. Those objects may be used to configure or arbitrate the communication, or simply to exchange application data. Communication objects are available to:

- Exchange process and service data.
- Process or system time synchronization.
- Error state supervision.
- Control and monitoring of node states.

iSV2-CAN series follow the communication rules:

- Comply with CAN 2.0A standard
- Comply with CANopen standard protocol DS 301 _V4.02
- Comply with CANopen standard protocol DSP 402 _V2.01

5.2.1 CANopen frame

CANopen protocol is based in CAN frames and uses one CAN frame for each CANopen message. There are two important parts of the frame that the user needs to modify: the arbitration field and the data field. The rest of the fields of the frame are normally automatically configured by the CAN hardware.

Arbitration field

In CANopen messages the identifier part of the arbitration field is known as Communication Object Identifier (COB-ID). It is divided into a 4-bit part function code and a 7-bit node-ID as depicted::

Bit number:	10	9	8	7	6	5	4	3	2	1	0
Identifier (COB-ID)											
Function code					Node-ID						

COB-ID description

Parallel to CAN, every node on a CANopen network must have a unique node-ID. The range of valid values comprises from 1 to 127. Zero is not allowed.

Similarly, the priority is determined by the COB-ID and RTR bits. As expected, the RTR bit on the arbitration field is used to request information from a remote node. In particular, it is used to implement the node guarding and TPDO request features, explained in the following chapters. With the exception of these two circumstances, the RTR bit is always set to zero.

The function code determines the communication object, which should be one of the allowed in CANopen. The final COB-ID of the object depends on the ID of which node receives or transmits the message, which allows to further establish priorities between nodes for the same function code.

In a master/slave communication, the message could be divided into two groups, as shown in the following tables.

- CANopen broadcast messages:

Communication Object	Function code(binary)	COB-ID(hex)
NMT service	0000b	0x000
SYNC	0001b	0x080

- CANopen peer-to-peer messages:

Communication Object	Function code(binary)	COB-ID(hex)	Object Dictionary
Emergency	0001b	0x080+Node-ID	1024H,1015H
TXPDO1(transmit)	0011b	0x180+Node-ID	1800H
RXPDO1(receive)	0100b	0x200+Node-ID	1400H
TXPDO2(transmit)	0101b	0x280+Node-ID	1801H
RXPDO2(receive)	0110b	0x300+Node-ID	1401H
TXPDO3(transmit)	0111b	0x380+Node-ID	1802H
RXPDO3(receive)	1000b	0x400+Node-ID	1402H
TXPDO4(transmit)	1001b	0x480+Node-ID	1803H
RXPDO4(receive)	1010b	0x500+Node-ID	1403H
SDO(transmit)	1011b	0x580+Node-ID	1200H
SDO(receive)	1100b	0x600+Node-ID	1200H
NMT error control	1110b	0x700+Node-ID	1016H~1017H

The COB-ID of No. 4 slave station TPDO2 = $0x280 + 4 = 0x284$

5.2.2 CANopen objects

In the CANopen protocol, there are defined three main sets of objects, organized in profile areas:

- **Communication profile area (0x1000 to 0x1FFF):** These objects relate to CANopen communication, as defined in the DS301 communication profile. Objects in this address range are used to configure CANopen messages, and for general CANopen network setting.
- **Manufacturer profile area (0x2000 to 0x5FFF):** These objects are manufacturer specific. Detailed information about the specific objects implemented in EMCL can be found all through this document.
- **Device profile area (0x6000 to 0x9FFF):** These objects are standardized device profile objects as defined in the DSP402 profile, which is the CANopen profile for servo drives.

This chapter is focused on the Communication profile area. DS301 defines special objects for the

communication profile, responsible of managing system elements related to CANopen communications.

5.3 NMT

The network management (NMT) protocols provide services for network initialization, error control and device status control. NMT objects are used for executing NMT services. The NMT follows a master-slave structure and therefore requires that one CANopen device in the network fulfils the function of the NMT master. All other CANopen devices are regarded as NMT slaves. An NMT slave is uniquely identified in the network by its Node ID, a value in the range of 1 to 127.

The NMT state machine defines the communication status for CANopen devices.

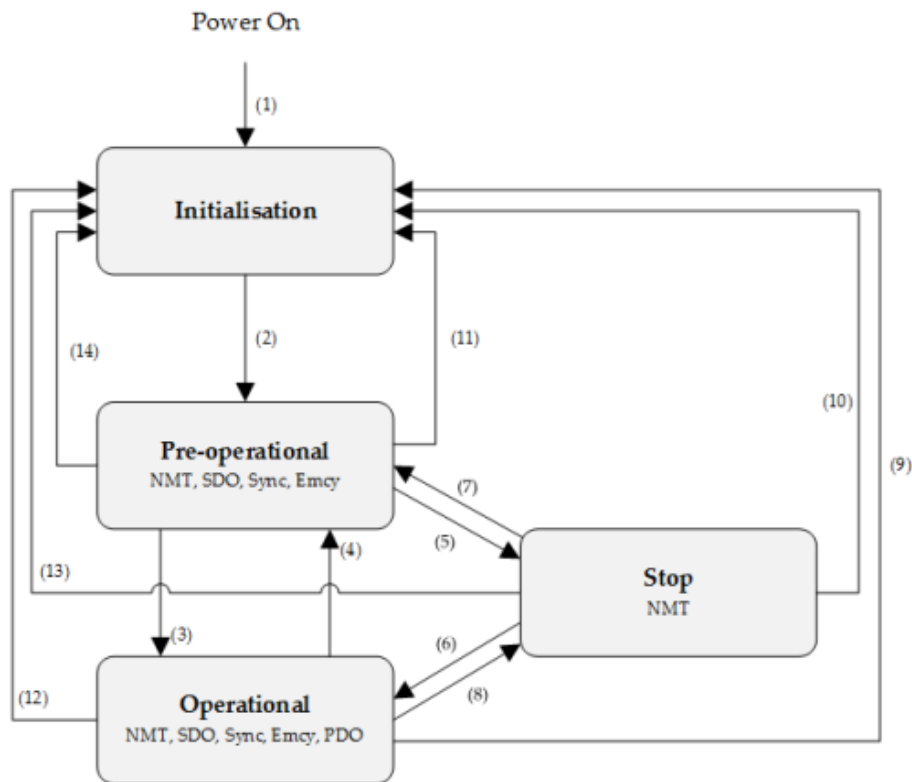

NMT state machine

Transition	Event
(1)	After power on the system goes directly to <i>initialization</i> state
(1)	Once <i>initialization</i> is completed the system enters to <i>Pre-operational</i> state
(3), (6)	Reception of <i>Start remote node</i> command
(4), (7)	Reception of <i>Enter pre-operational state</i> command
(5), (8)	Reception of <i>Stop remote node</i> command
(9), (10), (11)	Reception of <i>Reset remote node</i> command
(12), (13), (14)	Reception of <i>Reset communication</i> command

NMT state initialization

The initialization state could be divided into three sub-states that are executed in a sequential way: Initializing (performs the basic CANopen initializations), Reset application (in where all manufacturer-specific and standardized profile area parameters are set) and Reset communication (where the communication profile and parameters are set).

At the end of initialization state the device sends a boot-up message and goes directly to Pre-Operational state.

NMT state pre-operational

In Pre-Operational state, the communication using SDO messages is possible. PDO message are not yet defined and therefore communication using these message is not allowed. The device will pass to Operational message after receiving a NMT start node command.

Normally the master puts a node in Pre-Operational state during the set-up and configuration of device parameters.

NMT state operational

In Operational state all kind of messages are active, even PDO messages.

NMT state stopped

When entering in Stopped state, the device is forced to stop all communications with the exception of the NMT commands. (Node Guarding & Life Guarding).

NMT states and communication object relation

Following table shows the relation between communication states and communication objects. Services on the listed communication objects may only be executed if the devices involved in the communication are in the appropriate communication states

5.3.1 NMT services

The structure of each NMT service command is as follows:

COB-ID(hex)	Number of Bytes	Data field	
		Byte 0	Byte 1
0x000	2	Command specifier	Node-ID

The possible NMT services commands are the followings:

Command specifier(hex)	Command description
01	Start remote node
02	Stop remote node
80	Enter pre-operational
81	Reset node
82	Reset communication

Example of Node-ID=1 NMT services:

COB-ID(hex)	Number of Bytes	Data(hex)	Description
000	2	80 01	NMT Host commands node 1 into Pre-Operational state
000	2	01 01	NMT Host commands node 1 into Operational state
000	2	02 01	NMT Host commands node 1 into Pre-Operational state
000	2	82 01	NMT Host commands a communication reset to node 1
701	1	00	Node 1 response with a boot-up message

5.3.1 NMT error control

Protocol node guarding

The NMT Master can monitor the communication status of each node using the Node Guarding protocol.

During node guarding, a controller is polled periodically and is expected to respond with its communication state within a pre-defined time frame. Note that responses indicating an acceptable state will alternate between

two different values due to a toggle bit in the returned value. If there is no response, or an unacceptable state occurs, the NMT master could report an error to its host application.

The NMT master sends a node guarding request using the following a Remote Frame message:

COB-ID(hex)	Number of Bytes	RTR
0x700+Node-ID	0	1

The NMT slave will generate a node guarding answer using the following message:

COB-ID(hex)	Number of Bytes	RTR	Data field(Byte 1)	
			Bit 7	Bit 6 to 0
0x700+Node-ID	1	1	Toggle	NMT communication state

Note that the slave answers toggling a bit between consecutive responses. The value of the toggle bit of the first response after the guarding protocol becomes active is zero.

The state of the heartbeat producer could be one of the followings:

Communication State value(hex)	State definition
00	Boot-up
04	Stopped
05	Operational
7F	Pre-operational

Example of NMT Node guarding:

COB-ID(hex)	Number of Bytes	Data(hex)	Description
701	0	-	Master sends a CAN remote frame without data to node 1
701	1	7F	Node 1 sends the actual NMT state (pre-operational) toggling the 7 th bit
701	0	0	Master sends a CAN remote frame without data to node 1
701	1	FF	Node 1 sends the actual NMT state (pre-operational) toggling the 7 th bit

Protocol heartbeat

The heartbeat protocol defines an error control service without need for remote frame. A heartbeat producer (in this scope a controller) transmits a Heartbeat message cyclically. Transmit cycle of heartbeat message could be configured using the object Producer heartbeat time (0x1017). If the Heartbeat is not received by the consumer (in this scope a master) within an expected period of time (normally specified as Consumer heartbeat time)

It could report an error to its host application.

The heartbeat message generated by the producer will be as follows:

COB-ID(hex)	Number of Bytes	Data field(Byte 1)	
		Bit 7	Bit 6 to 0
0x700+Node-ID	1	Reserved	NMT communication state

The state of the heartbeat producer could be one of the followings:

Communication State value(hex)	State definition
00	Boot-up
04	Stopped
05	Operational
7F	Pre-operational

Example of NMT heartbeat:

COB-ID(hex)	Number of Bytes	Data(hex)	Description
705	1	7F	Node 5 sends a heartbeat indicating pre-operational state
705	1	7F	After producer heartbeat time, Node 5 sends again a heartbeat indicating pre-operational state

Protocol life guarding

In Life guarding protocol the NMT slave monitors the status of the NMT master. This protocol utilizes the objects Guard time (0x100C) and Life time factor (0x100D) to determine a "Lifetime" for each NMT slave (Lifetime = Guard Time * Life Time Factor). If a node does not receive a Node Guard message within its Lifetime, the node assumes communication with the host is lost sends an emergency message and performs a fault reaction. Each node may have a different Lifetime.

Example of NMT life guarding:

COB-ID(hex)	Number of Bytes	RTR	Data(hex)	Description
705	1	1	-	Master sends a CAN remote frame without data to node 1
705	1	1	-	Master sends a CAN remote frame without data to node 1
...	Delay Higher than Guard Time*Life Time Factor
81	8	0	30 81 11 00 00 00 00 00	Node 1 send an EMCY indicating the lifeguard error

Protocol boot-up

An NMT slave issues the Boot-up message to indicate to the NMT-Master that it has entered the state Pre-operational from state Initialising

Example of NMT Boot-up:

COB-ID(hex)	Number of Bytes	Data(hex)	Description
705	1	00	Node 5 sends a boot-up NMT message

5.4 SDO

The SDO are communication channels with two basic characteristics:

- Client / Server relationship
- It provides access to the dictionary of CANopen objects of the device.

The SDO are used to transfer multiple object content simultaneously (each with an arbitrary amount of information) from client to server and vice versa.

SDO are transferred as a sequence of segments. Before sending the segments there is an initialization process in which the server and clients prepare themselves to send the segments. However, it is also possible to send information (up to 4bytes) during the initialization process. This mechanism is called SDO expedited transfer.

The SDO message will be as follows:

Master to Slave(Write)

COB-ID(hex)	Byte 0	Byte 1:2	Byte 3	Byte 4:7
0x600+Node-ID	SDO send Command	Object Dictionary	Index	Data

Slave to Master(Feedback)

COB-ID(hex)	Byte 0	Byte 1:2	Byte 3	Byte 4:7
0x580+Node-ID	SDO receive Command	Object Dictionary	Index	Data

Example of SDO:

- The master uses the SDO to write data to objects in the nodes

COB-ID	Byte 0	Byte 1	Byte 2	Byte 3	Byte 4	Byte 5	Byte 6	Byte 7	Description
Master to Slave(Write)									Setup into Node 2 1081h-03=20F0(hex)
602	2B	01	18	03	F0	20	00	00	
Slave to Master(Feedback)									
582	60	01	18	03	00	00	00	00	

- The master uses the SDO to read data from objects in the nodes

COB-ID	Byte 0	Byte 1	Byte 2	Byte 3	Byte 4	Byte 5	Byte 6	Byte 7	Description
Master to Slave(Write)									Read from Node 2 1081h-03=20F0(hex)
602	40	01	18	03	00	00	00	00	
Slave to Master(Feedback)									
582	4B	01	18	03	F0	20	00	00	

5.5 PDO

PDOs are messages send without confirmation used for real time information transfer. PDOs are mapped to a single CAN frame and can contain multiple object dictionary entries with a maximum of 8 bytes of data. Each PDO has an identifier and is transmitted by only one node in the network, however it could be received by more than one node. PDOs must be configured previous to using them.

There are two types of PDO messages: Transmit PDO (TPDO) and Receive PDO (RPDO).

The trigger event of the PDO message could be configured using the communication parameter object and the object dictionary entries transmitted could be also defined using the PDO mapping list.

Therefore, each PDO is defined by means of:

- A PDO communication parameter
- A PDO mapping object

iSV2-CAN series include 4 RPDO and 4 TPDO.

Transmit PDO (TPDO)

TPDOs are configured to send data from node to master after the occurrence of a trigger event or after a remote request by means of a RTR.

TPDOs have three transmission types:

- **Internal event or timer:** Message transmission is triggered when the value mapped into the PDO has changed or when the specified time (event-timer) has elapsed. PDO transmission is controlled by producer.
- **Remotely request:** Message transmission is initiated on receipt of a RTR message. PDO transmission is driven by the PDO consumer.

- **Synchronously trigger:** Message transmission is triggered by the reception of a certain number of SYNC objects (see TPDO1 definition for further information). The PDO transmission is controlled by the SYNC producer.

Example of an internal event TPDO:

COB-ID(hex)	Number of Bytes	Data(hex)	Description
182	2	63 22	Node 2 sends the Transmit PDO1 with a content value of 0x2263.

Receive PDO (RPDO)

The master uses the RPDO to write data to objects in the nodes.

RPDOs have two transmission types:

- **Asynchronous:** Message content is applied upon receipt of the RPDO. The PDO reception is controlled by the PDO producer.
- **Synchronously trigger:** Message content is applied after the reception of a certain number of SYNC objects. The PDO reception is controlled by the SYNC producer.

Example of an asynchronous RPDO:

COB-ID(hex)	Number of Bytes	Data(hex)	Description
202	2	22 12	Master sends a RPDO1 to Node 2 with a content value of 0x1222.

5.6 SYNC

SYNC object is a broadcast message sent by one of the devices in the bus (normally the master) to provide synchronization to the network and to allow coordination between nodes. The nodes could be programmed to return any variable (actual position, etc) by means of TPDO at reception of SYNC object. The SYNC object has no data.

Example of SYNC:

COB-ID(hex)	Number of Bytes	Data(hex)	Description
80	0	-	Producer sends a SYNC message to all bus nodes.

5.7 EMCY

Emergency objects are triggered by the occurrence of a CANopen device internal error situation and are transmitted from an emergency producer (normally a node) on the CANopen device. An emergency object is sent only once per error event. Zero or more emergency consumers may receive the emergency object.

COB-ID(hex)	Byte number:	1	2	3	4	5	6	7	8
80+Node ID		Emergency error codes (Object 0x603F)		Error registers (Object 0x1001)	Reserved				

iSV2-CAN series include Emergency error codes (Object 0x603F):

Emergency error codes	Description
0000H	-
8110H	CAN bus over-run

8120H	CAN in error passive mode
8130H	Lifeguard error
8140H	Recovered from CAN bus off
8141H	CAN Bus off occurred
8150H	Send COB-ID conflicts
8210H	PDO not processed due to length error
8220H	PDO exceeds length error

iSV2-CAN series include Error registers (Object 0x1001):

Bit	Description
0	Generic Error
1	Current
2	Voltage
3	Temperature
4	Communication
5	Error specified by device protocol
6	Reserved
7	Leadshine specific error

Chapter 6 Trial Run



Attention

- Ground the earth terminal of the motor and drive without fail. the PE terminal of drive must be reliably connected with the grounding terminal of equipment.
- The drive power need with isolation transformer and power filter in order to guarantee the security and anti-jamming capability.
- Check the wiring to make sure correctness before power on.
- Install a emergency stop protection circuit externally, the protection can stop running immediately to prevent accident happened and the power can be cut off immediately.
- If drive alarm occurs, the cause of alarm should be excluded and Svon signal must be invalid before restarting the drive.
- Please don't touch terminal strip or separate the wiring.

Note: there are two kinds of trial run : trial run without load and trial run with load . The user need to test the drive without load for safety first.

6.1 Inspection Before trial Run

Table 6.1 Inspection Item Before Run

No	Item	Content
1	Wiring Inspection	1. Ensure the following terminals are properly wired and securely connected : the input power terminals, control signal terminal CN1, communication terminal 2. short among power input lines and motor output lines are forbidden , and no short connected with PG ground.
2	Confirmation of power supply	The range of control power input Vdc, GND must be in the rated range (24-60Vdc).
3	Fixing of position	the motor and drive must be firmly fixed
4	Inspection without load	the motor shaft must not be with a mechanical load.
5	Inspection on control signal	1. all of the control switch must be placed in OFF state. 2. servo enable input Srv_on must be in OFF state.

6.2 iSV2-CAN motion control procedure

- A. The CANopen master sends "control word (6040h)" to initialize the drive.
- B. Drive feedback "status word (6041h)" to the master to show ready status (status word indication).
- C. Master send enable command (control word switch).
- D. The drive enables and feeds back to the master.
- E. The master station sends homing command to return to homing position
- F. Drive returns to homing position complete and notifies master station (status word indication)
- G. The master station sends the position mode command for position movement (position motion parameters and control word) or sends the speed command for speed movement (speed motion parameters and control word).
- H. When the drive is finished executing the movement (position motion/velocity motion), iSV2-CAN feeds back the position/speed to the master station for monitoring during the motion
- I. The master station sends commands for the next motion.

6.3 CIA 402 State Machine

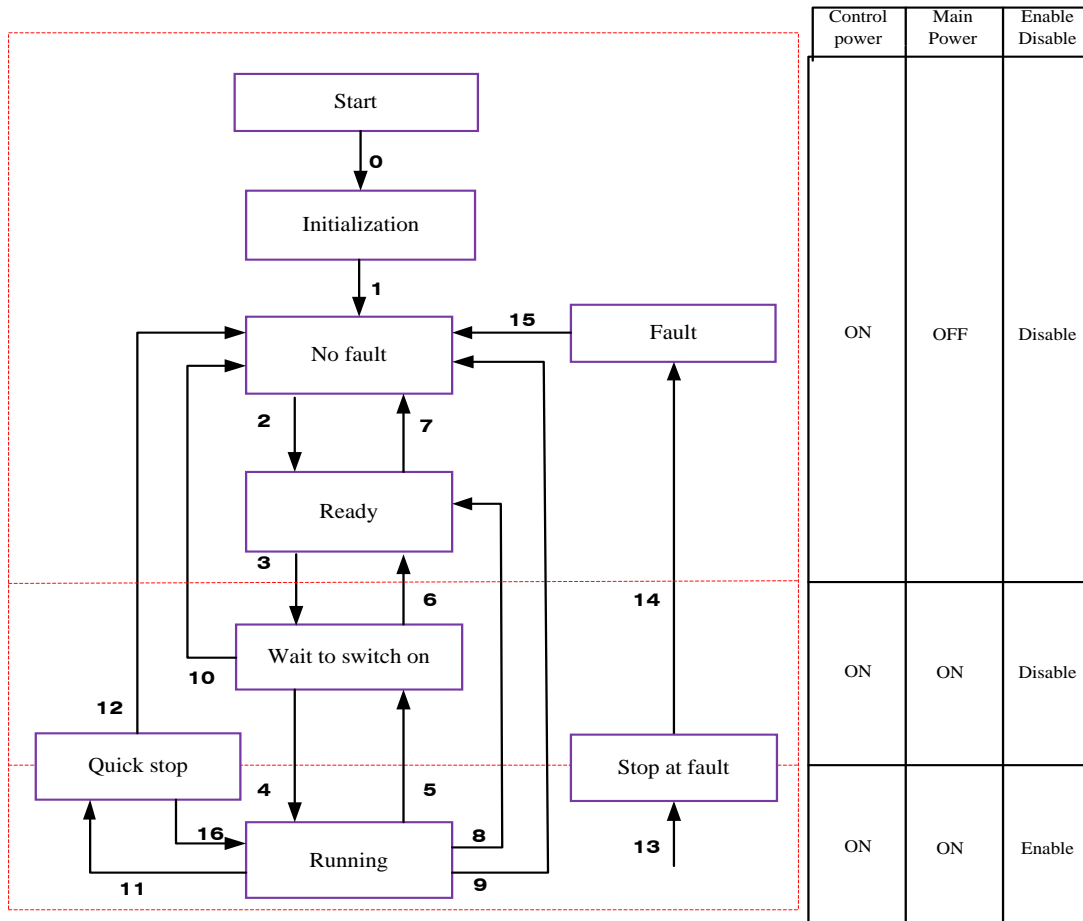

Figure 6.1 iSV2-CAN 402 State Machine switchover diagram

The states are described in the following table 6.2

Table 6.2 State description

States	Details
Initialization	Initialization of the servo drive and self-check have been done. Parameter setting or drive function cannot be implemented. If there is brake, the brake will not release, servo disabled.
No fault	No fault exists in the servo drive or the fault is eliminated Parameter setting of the servo drive is allowed.
Ready	The servo drive is ready. Parameter setting of the servo drive is allowed.
Wait to switch on	The servo drive waits to switch on. Parameter setting of the servo drive is allowed.
Running	The servo drive is in normal running state; a certain control mode is enabled; The motor is energized, and rotates when the reference is not 0. Parameters with the setting condition of 'during running' can be set.
Quick stop	The quick stop function is enabled, and the servo drive executes quick stop. Parameters with the setting condition of 'during running' can be set.
Stop at fault	A fault occurs, and the servo drive stops. Parameters with the setting condition of 'during running' can be set.
Fault	The stop process is completed, and all the drive function are inhibited. Parameter setting is allowed for users to eliminate faults.

The conversion of CIA402 state machine is accomplished by the control word (6040h) of the iSV2-CAN servo system operated by the master station.

6.4 Common Functions for All Modes

6.4.1 Motor Rotation Direction

The Rotation Direction is defined in 607Eh.

Mode		Value
Position mode	PP HM	0: Rotate in the same direction as the position command 128: Rotate in the opposite direction as the position command
Velocity mode	PV	0: Rotate in the same direction as the position command 64: Rotate in the opposite direction as the position command
Torque mode	PT	0: Rotate in the same direction as the position command 32: Rotate in the opposite direction as the position command
ALL mode		0: Rotate in the same direction as the position command 224: Rotate in the opposite direction as the position command

6.2.2 Drive Stop

If the 6085h is not 0, the 6085h object will be used as the deceleration speed for quick stop. If the 6085h is 0, the servo will be stopped quickly according to the maximum current limit.

The emergency stop when meet limit switch, motor will stop rapidly according to the maximum current limit.

When the state machine is switched to an enable state the motor will stop freely. When bit8(Halt) of 6040h is 1, the motor will stop with deceleration set in 6084h.

6.4.3 Electronic Gear Ratio

iSV2-CAN position mode include protocol position mode (PP) and homing mode (HM), only in these two modes does the electronic gear ratio valid.

Electronic gear ratio range is 1/1000~8000, otherwise ErA00 warning will appear (the warning is not saved, after modification to a reasonable range, the l alarm showing in operation pane will disappear automatically, but the 402 state will still be in the "error" state, write 0x80 into 6040h to reset.

The electronic gear ratio setting is defined by 608Fh(Position encoder resolution),6091h(Gear ratio) and 6092h(Feed constant), which can only be effectively changed in the pre-operational state.

608Fh(Position encoder resolution) is the resolution of the encoder, which is read internally without additional setting. 6092h_01 represents the number of pulses that can be set for each rotation of the motor. 6091h_01/6091h_02 is real-time update effective.

The electronic gear subdivision method can be determined by modifying 6092h_01(Feed constant)

The subdivision method of electronic gear can be determined by modifying 6092h_01(Feed constant) .

1、 If 6092h_01(Feed constant) is not equal to 608Fh(Position encoder resolution), then:

$$\text{Electronic gear ratio} = \text{encoder resolution} / 6092h_01$$

2、 If 6092h_01(Feed constant) is equal to 608Fh(Position encoder resolution), then:

$$\text{Electronic gear ratio} = 6091h_01/6091h_02$$

Electronic gear ratio range is 1/1000~8000.

Note: when the setting value exceeds this range, the error will be reported and automatically reset to the

default value. The default values of 6091_01, 6091_02 and 6092_01 are 1, 1 and 10000.

6.4.4 Control Word

The binary representation of the controlword (6040) is as follows:

Bit	15~11	10~9	8	7	6~4	3	2	1	0
Definition	-	-	Halt	Fault reset	Mode specific	Enable operation	Quick stop	Enable voltage	Switch on

Command	Bit7 and Bit0 to Bit3					6040 Value	402 State machine *1)
	7: Fault reset	3: Enable operation	2: Quick stop	1: Enable voltage	0: Switch on		
Power off	0	×	1	1	0	0006h	2;6;8
Switch on	0	0	1	1	1	0007h	3*
Switch on	0	1	1	1	1	000Fh	3**
No voltage output	0	×	×	0	×	0000h	7;9;10;12
Quick stop	0	×	0	1	×	0002h	7;10;11
Operation disable	0	0	1	1	1	0007h	5
Operation enable	0	1	1	1	1	000Fh	4;16
Fault reset	Rising edge	×	×	×	×	0080h	15

× is not affected by this bit state

* indicates that this transition is performed in the device start state

** indicates that it has no effect on the start state and remains in the start state

*1) The state machine switch corresponds to figure 6.1

The definition of bit 8 and bit 6~4 in different operation modes are shown in the following table

Bit	Operation Mode			
	Profile Position (PP)	Profile Velocity (PV)	Profile Torque (PT)	Homing (HM)
8	Halt	Halt	Halt	Halt
6	Abs / Rel	-	-	-
5	Change set immediately	-	-	-
4	New set-point	-	-	Homing operation start

6.4.5 Status Word

Bit definition of Status Word 6041h.

The binary representation of the statusword (6041) is as follows:

Bit	Definition
15~14	Reserved
13~12	Mode specific
11	Position limit active
10	Target reached
9	Remote
8	Mode specific
7	Reserved
6	Switch on disabled
5	Quick stop
4	Voltage output
3	Fault
2	Operation enable
1	Switch on
0	Ready to switch on

Bit 11 is valid when the software or hardware limit is in effect.

The combination of bit 6 and bit 0~3 represents the device state shown in following table

Combination of bit 6 and bit 3~0	Description
xxxx,xxxx,x0xx,0000	Not ready to switch on
xxxx,xxxx,x1xx,0000	Switch on disabled
xxxx,xxxx,x01x,0001	Ready to switch on
xxxx,xxxx,x01x,0011	Switch on
xxxx,xxxx,x01x,0111	Operation enabled
xxxx,xxxx,x00x,0111	Quick stop active
xxxx,xxxx,x0xx,1111	Fault reaction active
xxxx,xxxx,x0xx,1000	Fault

x is not affected by this bit state

The definition of bit 8 and bit 12~13 in different operation modes are shown in the following table

Bit	Operation Mode			
	Profile Position (PP)	Profile Velocity (PV)	Profile Torque (PT)	Homing (HM)
13	Following error	-	-	Homing error
12	-	Velocity is 0	-	Homing attained
8	Abnormal stop	-	-	Abnormal stop

6.4.6 Drive Enable

This section describes how to enable the drive by control word (6040h), how to view the drive enable states by status word (6041h)

Steps:

- 1: Write 0 to the control word 6040h

- 2: Write 6 to the control word 6040h
- 3: Write 7 to the control word 6040h
- 4: Write F to the control word 6040h

6.5 Profile position mode

When using network command source, the validation process for a new target position is the following:

- The requested target position is sent to the motion controller.
- After the new target position has been delivered to the drive, the motion controller expects a controlword with a rising edge of the "New set point " bit.
- Upon reception of the controlword with the rising edge of the "New set point " bit, the motion controller issues a statusword with a "Set point acknowledge" bit rising edge.
- To signal its ability to accept new set points, the motion controller issues a statusword with the "Set point acknowledge" bit cleared.

If the system was not processing any position, the new position is processed and the motion starts.

Nevertheless, if there was a previous set point being processed. the behavior of the system depends on the "Change set immediately " bit in the controlword:

- If the "Change set immediately" bit of the controlword is 1, the target point is the new set point, and motion is started to reach this new set point.

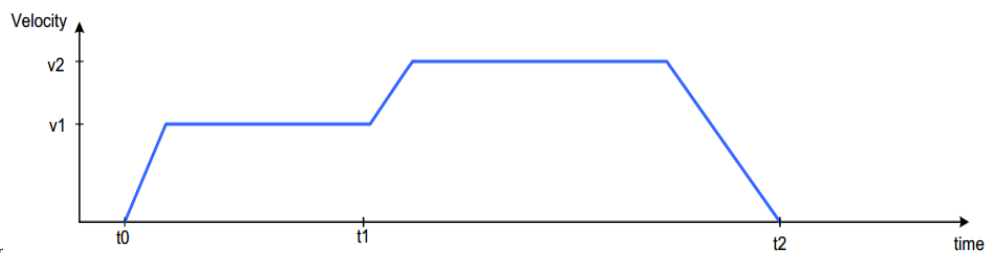

- If t buffer of set points, and the motion to the previous set being processed is not altered.

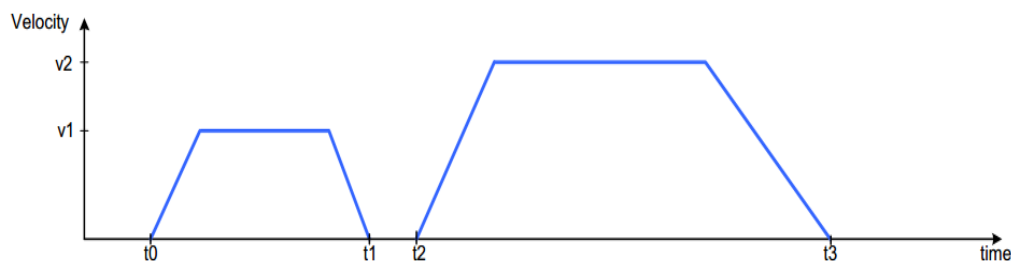

6.5.1 Controlword in profile position mode

The profile position mode uses some bits of the controlword and the statusword for mode specific purposes.

The binary representation of the controlword(6040) in profile position mode is as follows:

Bit	15~9	8	7	6	5	4	3	2	1	0
	-	Halt	Fault reset	Abs / rel	Change set immediately	New set-point	Enable operation	Quick stop	Enable voltage	Switch on

If no positioning is in progress, the rising edge of bit 4 will start the positioning of the axis. In case a positioning is in progress, the definitions given in the following table shall be used.

Change set	New	Description
------------	-----	-------------

immediately	set-point	
0	0 1	Actual positioning will be completed (target reached) before the next one gets started (Set of set-points mode)
1	0 1	Next positioning shall be started immediately interrupting the actual one.

Next table defines the values for bit 6 and 8 of the controlword.

Name	Value	Description
Abs / rel	0	Target position is an absolute value.
	1	Target position is a relative value.
Halt	0	Execute positioning.
	1	Stop axis with profile deceleration(6084h).

6.5.2 Statusword in profile position mode

The binary representation of the statusword(6041) in profile position mode is as follows:

Bit	Definition
15~14	Reserved
13	Following error
12	-
11	Position limit active
10	Target reached
9	Remote
8	Abnormal stop
7	Reserved
6	Switch on disabled
5	Quick stop
4	Voltage output
3	Fault
2	Operation enable
1	Switch on
0	Ready to switch on

The meaning of each bit is described below, depending on its value:

Name	Value	Description
Target reached	0	Halt=0: Target position not reached Halt=1: Axis decelerates
	1	Halt=0: Target position reached Halt=1: Axis has velocity 0
Following error	0	No following error
	0	Following error

6.5.3 Related objects

Object Dictionary	Description	Setup value	Units
6060H	Mode of operation	1	

6040H	Controlword		
6041H	Statusword		
607AH	Target position		Pulse
6081H	Profile velocity		Pulse /s
6083H	Profile acceleration		Pulse /s ²
6084H	Profile deceleration		Pulse /s ²
6092H	Feed constant		

6.5.4 Example of profile position mode

No	Command	Function
1	81 00 00 00 00 00 00 00	Reset all nodes. If you need to reset the specified node, the node number is changed by modifying the two digits after 81 (note that it is hexadecimal)
2	01 00 00 00 00 00 00 00	Start remote control for all nodes. If remote control of the specified node needs to be started, the node number is changed by modifying the two-digit number after 01 (note that it is hexadecimal).
3	2b 40 60 00 06 00 00 00	Write control word as 06H, state machine switching status Switch On Disabled->Ready to Switch On
4	2b 40 60 00 07 00 00 00	Read control word as 07H, state machine switching status Ready to Switch On-> Switched On The relay in the actuator is engaged
5	2b 40 60 00 0f 00 00 00	Write control word as 0fH, state machine switching status Switched On->Operation Enable. Servo-Enabled
6	2f 60 60 00 01 00 00 00	Write operation mode as 1H, profile position mode
7	23 81 60 00 90 D0 03 00	Write the protocol speed as 3D090H(1500rpm, 10000p/r)
8	23 83 60 00 90 D0 03 00	Write the protocol acceleration as 3D090H(1500rpm/s, 10000p/r)
9	23 7a 60 00 20 4E 00 00	Write the target location at 4E20H (2 rotations, 10000p/r)
10	2b 40 60 00 4f 00 00 00	Write the control word as 4fH, Set to relative motion mode
11	2b 40 60 00 5f 00 00 00	Write the control word as 5fH. Execute positioning
12	2b 40 60 00 07 00 00 00	Write control word as 07H,state machine switching status Operation Enable -> Switched On. Servo-Disabled
13	2b 40 60 00 06 00 00 00	Write control word as 06H,state machine switching status Switched On ->Ready to Switch On

Notes: The COB-ID of step 1 (reset node) and step 2 (start node) is "0x000", and the COB-ID of the remaining steps is the address 0x600 + Node ID

6.6 Profile velocity mode

Target velocity obtained from the command source is processed immediately on reception (system limits, etc.), and is delivered to the profiler afterwards. According to the predetermined parameters, the profiler generates and provides the control unit with the instantaneous target torque to be achieved. Upon reaching the target, a statusword is issued as a notification to other nodes.

6.6.1 Controlword in profile velocity mode

The profile velocity mode uses some bits of the controlword and the statusword for mode specific purposes.

The binary representation of the controlword(6040) in profile velocity mode is as follows:

Bit	15~9	8	7	6	5	4	3	2	1	0
	-	Halt	Fault reset	-	-	-	Enable operation	Quick stop	Enable voltage	Switch on

The action taken is described below, depending on the value of each bit:

Name	Value	Description
Halt	0	Execute velocity movement
	1	Stop the movement

6.6.2 Statusword in profile velocity mode

The binary representation of the statusword(6041) in profile velocity mode is as follows:

Bit	Definition
15~14	-
13	-
12	Velocity is 0
11	-
10	Target reached
9	-
8	-
7	-
6	Switch on disabled
5	Quick stop
4	Voltage output
3	Fault
2	Operation enable
1	Switch on
0	Ready to switch on

The meaning of each bit is described below, depending on its value:

Name	Value	Description
Target reached	0	Halt=0: Target velocity not reached Halt=1: Axis decelerates
	1	Halt=0: Target velocity reached Halt=1: Axis has velocity 0
Velocity is 0	0	Velocity is not equal 0
	0	Velocity is equal 0

6.6.3 Related objects

Object Dictionary	Description	Setup value	Units
6060H	Mode of operation	3	

6040H	Controlword		
6041H	Statusword		
60FFH	Target velocity		Pulse /s
6083H	Profile acceleration		Pulse /s ²
6084H	Profile deceleration		Pulse /s ²
606CH	Velocity actual value		Pulse /s
606BH	Velocity demand value		Pulse /s

6.6.4 Example of profile velocity mode

No	Command	Function
1	81 00 00 00 00 00 00 00	Reset all nodes. If you need to reset the specified node, the node number is changed by modifying the two digits after 81 (note that it is hexadecimal)
2	01 00 00 00 00 00 00 00	Start remote control for all nodes. If remote control of the specified node needs to be started, the node number is changed by modifying the two-digit number after 01 (note that it is hexadecimal).
3	2b 40 60 00 06 00 00 00	Write control word as 06H, state machine switching status Switch On Disabled->Ready to Switch On
4	2b 40 60 00 07 00 00 00	Read control word as 07H, state machine switching status Ready to Switch On-> Switched On The relay in the actuator is engaged at this point
5	2b 40 60 00 0f 00 00 00	Write control word as 0fH, state machine switching status Switched On->Operation Enable. Servo-Enabled
6	2f 60 60 00 03 00 00 00	Write operation mode as 3H, profile velocity mode
7	23 83 60 00 90D0 03 00	Write the protocol acceleration as 3D090H(1500rpm/s, 10000p/r)
8	23 ff 60 00 90 D0 03 00	Write the protocol speed as 3D090H(1500rpm, 10000p/r)
9	2b 40 60 00 07 00 00 00	Write control word as 07H,state machine switching status Operation Enable -> Switched On. Servo-Disabled
10	2b 40 60 00 06 00 00 00	Write control word as 06H,state machine switching status Switched On ->Ready to Switch On

Notes: The COB-ID of step 1 (reset node) and step 2 (start node) is "0x000", and the COB-ID of the remaining steps is the address 0x600 + Node ID

6.7 Profile torque mode

Target torque obtained from the command source is processed immediately on reception (system limits, etc.), and is delivered to the profiler afterwards. According to the predetermined parameters, the profiler generates and provides the control unit with the instantaneous target torque to be achieved. Upon reaching the target, a statusword is issued as a notification to other nodes.

6.7.1 Controlword in profile torque mode

The profile velocity mode uses some bits of the controlword and the statusword for mode specific purposes.

The binary representation of the controlword(6040) in profile torque mode is as follows:

Bit	15~9	8	7	6	5	4	3	2	1	0
Definition	-	Halt	Fault reset	-	-	-	Enable operation	Quick stop	Enable voltage	Switch on

The action taken is described below, depending on the value of each bit:

Name	Value	Description
Halt	0	Execute torque movement
	1	Stop the movement

6.7.2 Statusword in profile torque mode

The binary representation of the statusword(6041) in profile torque mode is as follows:

Bit	Definition
15~14	-
13	-
12	-
11	-
10	Target reached
9	-
8	-
7	-
6	Switch on disabled
5	Quick stop
4	Voltage output
3	Fault
2	Operation enable
1	Switch on
0	Ready to switch on

The meaning of each bit is described below, depending on its value:

Name	Value	Description
Target reached	0	Halt = 0: Target torque not reached Halt = 1: Axis decelerates
	1	Halt = 0: Target torque reached Halt = 1: Axis has velocity 0

6.7.3 Related objects

Object Dictionary	Description	Setup value	Units
6060H	Mode of operation	4	
6040H	Controlword		
6041H	Statusword		
6071H	Target torque		0.1%
6087H	Torque change rate		0.1%/s

6080H	Maximum motor speed	r/min
6074H	Torque demand	0.1%
6077H	Torque actual value	0.1%

6.7.4 Example of profile torque mode

No	Command	Function
1	81 00 00 00 00 00 00 00	Reset all nodes. If you need to reset the specified node, the node number is changed by modifying the two digits after 81 (note that it is hexadecimal)
2	01 00 00 00 00 00 00 00	Start remote control for all nodes. If remote control of the specified node needs to be started, the node number is changed by modifying the two-digit number after 01 (note that it is hexadecimal).
3	2b 40 60 00 06 00 00 00	Write control word as 06H, state machine switching status Switch On Disabled->Ready to Switch On
4	2b 40 60 00 07 00 00 00	Read control word as 07H, state machine switching status Ready to Switch On-> Switched On The relay in the actuator is engaged at this point
5	2b 40 60 00 0f 00 00 00	Write control word as 0fH, state machine switching status Switched On->Operation Enable. Servo-Enabled
6	2f 60 60 00 04 00 00 00	Write operation mode as 4H, profile torque mode
7	23 71 60 00 14 00 00 00	Write the torque value as 14H (20*0.1%=1% rated torque)
8	2b 74 20 00 e8 03 00 00	Write the speed limit (Pr3.21) as 3e8H (1000 RPM)
9	23 87 60 00 14 00 00 00	Write the rate of change in torque as 14H (That is, increases to 20*0.1% of the rated torque =2% /s)
10	2b 40 60 00 07 00 00 00	Write control word as 07H,state machine switching status Operation Enable -> Switched On. Servo-Disabled
11	2b 40 60 00 06 00 00 00	Write control word as 06H,state machine switching status Switched On ->Ready to Switch On

Notes: The COB-ID of step 1 (reset node) and step 2 (start node) is "0x000", and the COB-ID of the remaining steps is the address 0x600 + Node ID

6.8 Homing mode

Typically, in a homing method there are two homing speeds: the faster speed is used to find the mechanical limit, and the slower speed is used to find the index pulse. There is a compromise between search speed and homing precision, due to maximum axis deceleration and inertia.

6.8.1 Controlword in profile homing mode

The profile velocity mode uses some bits of the controlword and the statusword for mode specific purposes. The binary representation of the controlword(6040) in profile homing mode is as follows:

Bit	15~9	8	7	6	5	4	3	2	1	0
	-	Halt	Fault reset	-	-	Homing operation start	Enable operation	Quick stop	Enable voltage	Switch on

The action taken is described below, depending on the value of each bit:

Name	Value	Description
Homing operation start	0	Do not start homing procedure
	1	Start homing procedure
Halt	0	Execute the instruction of bit 4
	1	Stop axis with homing acceleration

6.8.2 Statusword in profile homing mode

The binary representation of the statusword(6041) in profile homing mode is as follows:

Bit	Definition
15~14	-
13	Homing error
12	Homing attained
11	-
10	Target reached
9	-
8	Abnormal stop
7	-
6	Switch on disabled
5	Quick stop
4	Voltage output
3	Fault
2	Operation enable
1	Switch on
0	Ready to switch on

The meaning of each bit is described below, depending on its value:

Homing error	Homing attained	Target reached	Description
0	0	0	Homing procedure is in progress
0	0	1	Homing procedure is interrupted or not started
0	1	0	Homing is attained but target is not reached
0	1	1	Homing mode carried out successfully
1	0	0	Homing error occurred; Homing mode carried out not successfully; Velocity is not zero

1	0	1	Homing error occurred; Homing mode carried out not successfully; Velocity is zero
1	1	x	Reserved

6.8.3 Related objects

Object Dictionary	Description	Setup value	Units
6060H	Mode of operation	-	
6040H	Controlword		
6041H	Statusword		
6098H	Homing method		
6099H	Homing speeds		Command unit /s
609AH	Homing acceleration		Command unit /s ²
607CH	Home offset		Command unit

6.8.4 Example of homing mode

No	Command	Function
1	81 00 00 00 00 00 00 00	Reset all nodes. If you need to reset the specified node, the node number is changed by modifying the two digits after 81 (note that it is hexadecimal)
2	01 00 00 00 00 00 00 00	Start remote control for all nodes. If remote control of the specified node needs to be started, the node number is changed by modifying the two-digit number after 01 (note that it is hexadecimal).
3	2b 40 60 00 06 00 00 00	Write control word as 06H, state machine switching status Switch On Disabled->Ready to Switch On
4	2b 40 60 00 07 00 00 00	Read control word as 07H, state machine switching status Ready to Switch On-> Switched On The relay in the actuator is engaged at this point
5	2b 40 60 00 0f 00 00 00	Write control word as 0fH, state machine switching status Switched On->Operation Enable. Servo-Enabled
6	2f 60 60 00 06 00 00 00	Write operation mode as 6H, homing mode
7	23 99 60 01 30 75 00 00	Write home speed-high speed as 7530H (180rpm, 10000p/r)
8	23 99 60 02 20 4e 00 00	Write home speed-low speed as 4e20H (120rpm, 10000p/r)
9	23 9a 60 00 30 75 00 00	Write the acceleration of home speed as 7530H (180rpm/s,10000p/r)
10	2f 98 60 00 16 00 00 00	Write home method as 16H (The 22rd home method)
11	2b 40 60 00 1f 00 00 00	Write the control word as 1f, set the 4th digit of 6040H as 1, start homing mode.
12	2b 40 60 00 0f 00 00 00	Write the control word as 0f, and set the 4th digit of 6040H as 0, do not start homing mode.

14	2b 40 60 00 07 00 00 00	Write control word as 07H, state machine switching status Operation Enable -> Switched On. Servo-Disabled.
15	2b 40 60 00 06 00 00 00	Write control word as 06H, state machine switching status Switched On -> Ready to Switch On.

Notes: The COB-ID of step 1 (reset node) and step 2 (start node) is "0x000", and the COB-ID of the remaining steps is the address 0x600 + Node ID

6.8.5 Homing Method

Method -6: Search the homing point with low speed negative direction, when the torque reached then stop immediately.

● Start Position ■ Stop Position → Low speed of homing 6099h-02h

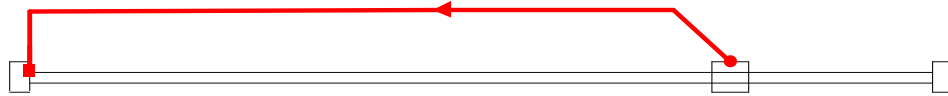

Method -5: Search the homing point with low speed positive direction, when the torque reached then stop immediately.

● Start Position ■ Stop Position → Low speed of homing 6099h-02h

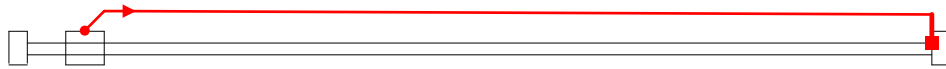

Method -4: Search the homing point with low speed negative direction, when the torque reached then change the motion direction, when the torque is gone then stop immediately.

● Start position ■ Stop Position → High speed 6099h-01h → Low speed 6099h-02h

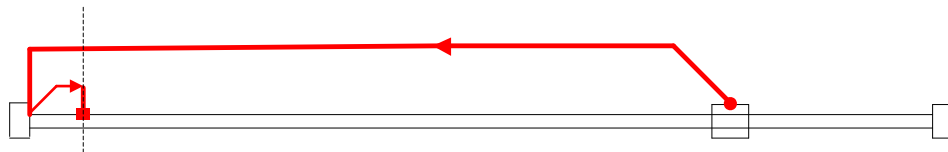

Method -3: Search the homing point with low speed positive direction, when the torque reached then change the motion direction, when the torque is gone then stop immediately.

● Start Position ■ Stop Position → High speed 6099h-01h → Low speed 6099h-02h

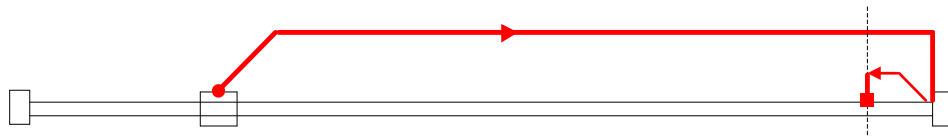

Method -2: Search the homing point with low speed negative direction, when the torque reached then reverse the direction, when the torque is gone and Z signal coming then stop immediately.

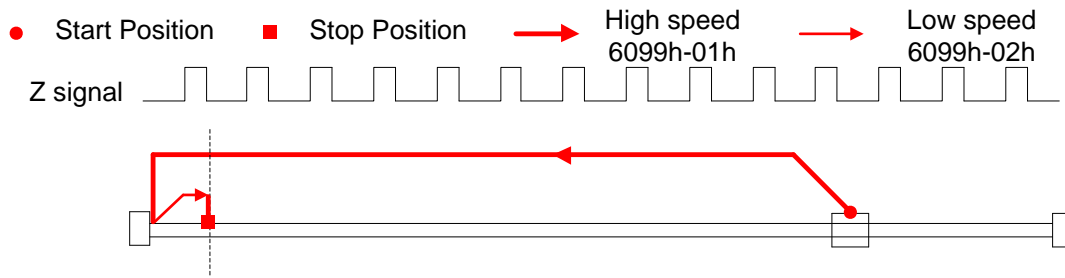

Method -1: Search the homing point with low speed positive direction, when the torque reached then reverse the direction, when the torque is gone and Z signal coming then stop immediately.

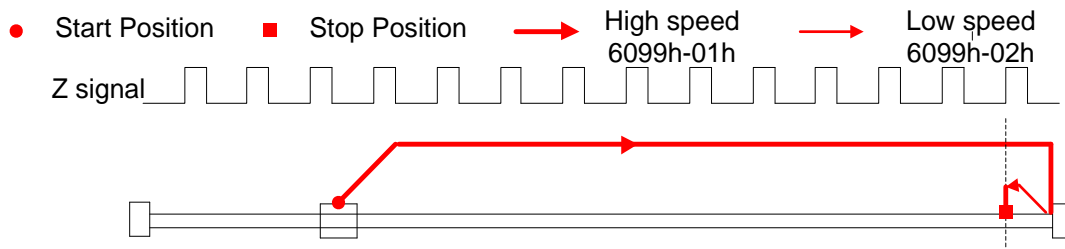

Method 1:

If the negative limit switch is invalid, the motor will move in negative direction at high speed until the negative limit switch signal is valid. The motor stops and starts moving at low speed in positive direction. The motor stops after leaving the negative limit switch and the first encoder Z signal is valid, as shown in figure.

If the motor stops at the negative limit position when it starts to move, the motor will move in positive direction at low speed. The motor stops after leaving the negative limit switch and the first encoder Z signal is valid, as shown in figure.

If the positive limit signal is valid during the homing process, the status word (6041h) bit 13 will be valid, indicating that the homing error and the motor will stop immediately.

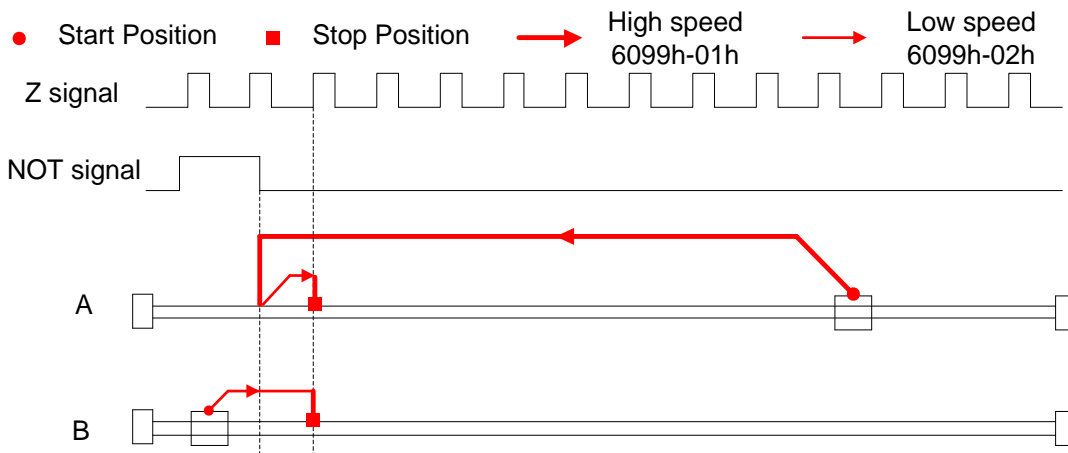

Method 2:

If the positive limit switch is invalid, the motor will move in positive direction at high speed until the positive limit switch signal is valid. The motor stops and starts moving at low speed in negative direction. The motor stops after leaving the positive limit switch and the first encoder Z signal is valid, as shown in figure.

If the motor stops at the positive limit position when it starts to move, the motor will move in negative direction at low speed. The motor stops after leaving the positive limit switch and the first encoder Z signal is valid, as shown in figure.

If the negative limit signal is valid during the homing process, the status word (6041h) bit 13 will be valid,

indicating that the homing error and the motor will stop immediately.

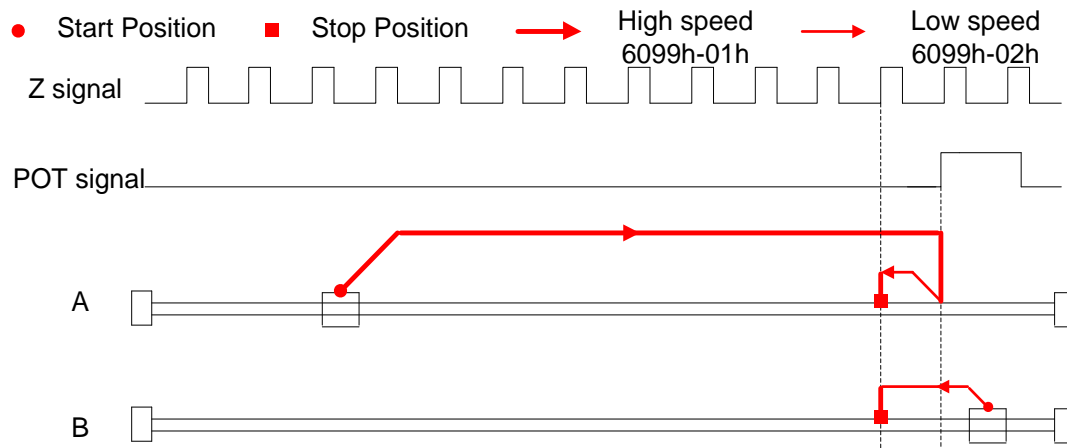

Method 3:

If the homing switch is invalid, the motor will move in positive direction at high speed until the homing switch signal is valid. The motor stops and starts moving at low speed in negative direction. The motor stops after leaving the homing switch and the first encoder Z signal is valid, as shown in figure.

If the motor stops at the homing switch position when it starts to move, the motor will move in negative direction at low speed. The motor stops after leaving the homing switch and the first encoder Z signal is valid, as shown in figure.

If the positive/negative limit switch signal is valid during the homing process, the status word (6041h) bit 13 will be valid, indicating that the homing error and the motor will stop immediately.

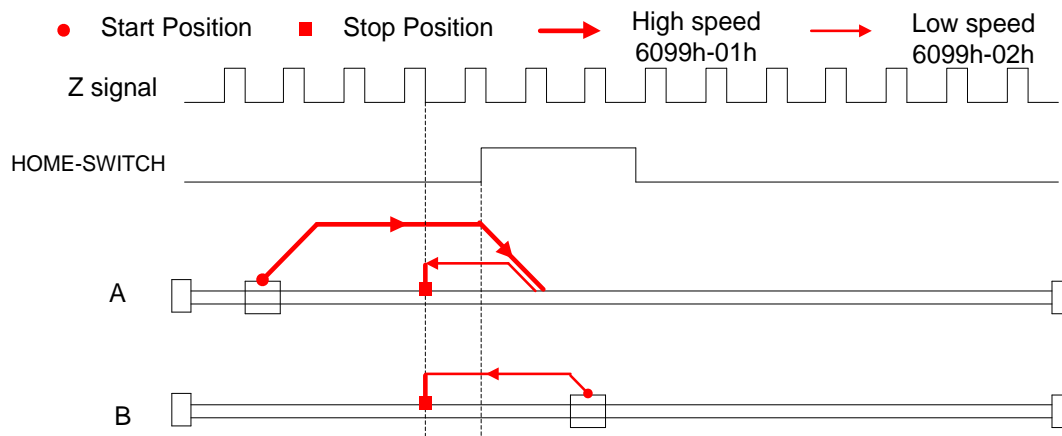

Method 4:

If the homing switch is invalid, the motor will move in positive direction at low speed until the homing switch signal is valid. The motor stops after leaving the homing switch and the first encoder Z signal is valid, as shown in figure.

If the motor stops at the homing switch position when it starts to move, the motor will move in negative direction at high speed until the homing switch invalid. Then the motor reverse the direction at low speed. The motor stops after the homing switch valid and the first encoder Z signal is valid, as shown in figure.

If the positive/negative limit switch signal is valid during the homing process, the status word (6041h) bit 13 will be valid, indicating that the homing error and the motor will stop immediately.

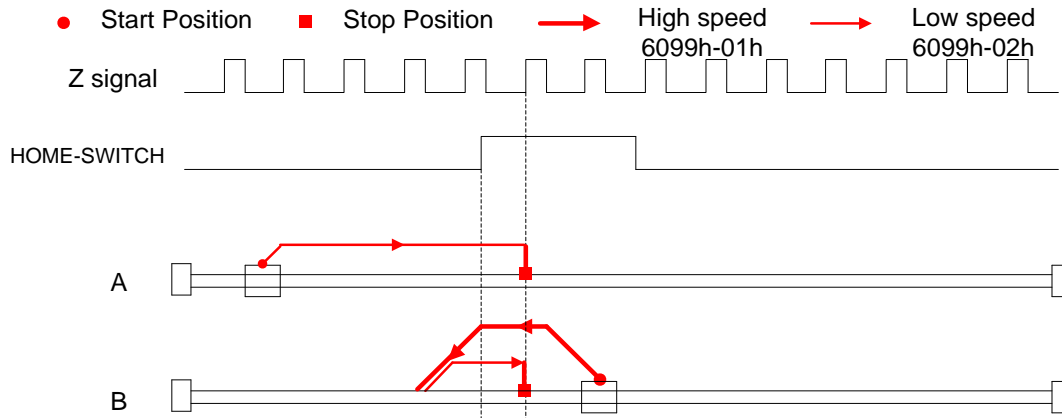
Method 5:

If the homing switch is invalid, the motor will move in negative direction at high speed until the homing switch signal is valid. Then the motor reverse the direction at low speed. The motor stops after leaving the homing switch and the first encoder Z signal is valid, as shown in figure.

If the motor stops at the homing switch position when it starts to move, the motor will move in positive direction at low speed. The motor stops after the homing switch invalid and the first encoder Z signal is valid, as shown in figure.

If the positive/negative limit switch signal is valid during the homing process, the status word (6041h) bit 13 will be valid, indicating that the homing error and the motor will stop immediately.

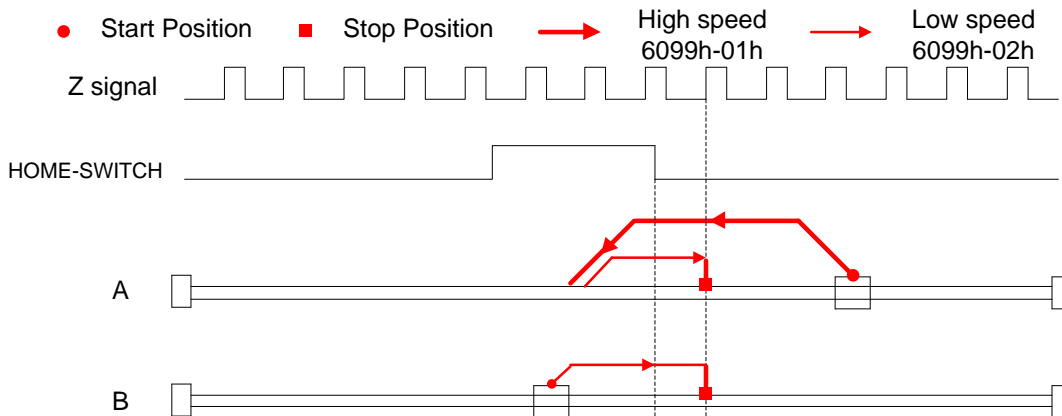
Method 6:

If the homing switch is invalid, the motor will move in negative direction at low speed until the homing switch signal is valid. The motor stops after leaving the homing switch and the first encoder Z signal is valid, as shown in figure.

If the motor stops at the homing switch position when it starts to move, the motor will move in positive direction at high speed until the homing switch invalid. Then the motor reverse the direction at low speed. The motor stops after the homing switch valid and the first encoder Z signal is valid, as shown in figure.

If the positive/negative limit switch signal is valid during the homing process, the status word (6041h) bit 13 will be valid, indicating that the homing error and the motor will stop immediately.

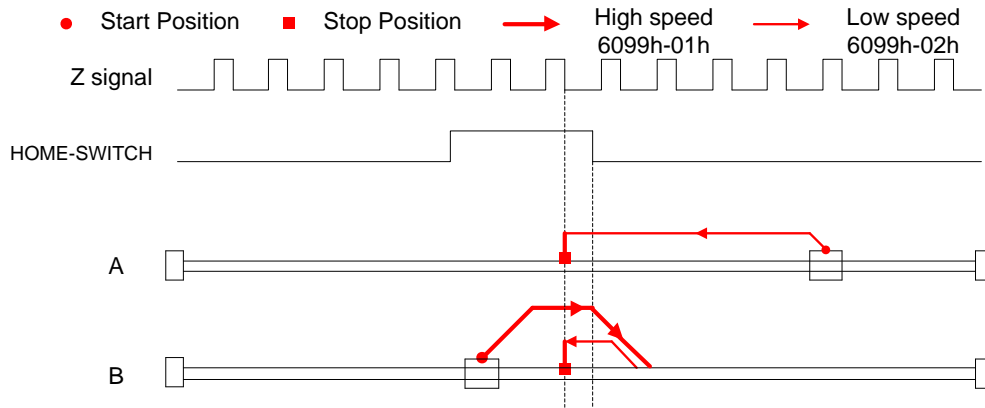

Method 7:

If the homing switch and positive limit switch is invalid, the motor will move in positive direction at high speed until the homing switch signal is valid. Then the motor reverse the direction at low speed. The motor stops after leaving the homing switch and the first encoder Z signal is valid, as shown in figure.

If the positive limit switch is invalid and motor stops at the homing switch position when it starts to move, the motor will move in negative direction at low speed until the homing switch signal is valid. The motor stops after leaving the homing switch and the first encoder Z signal is valid, as shown in figure.

If the homing switch and positive limit switch is invalid, the motor will move in positive direction at high speed until the positive limit switch valid. Then the motor reverse the direction at low speed. The motor stops after the homing switch valid and the first encoder Z signal is valid, as shown in figure.

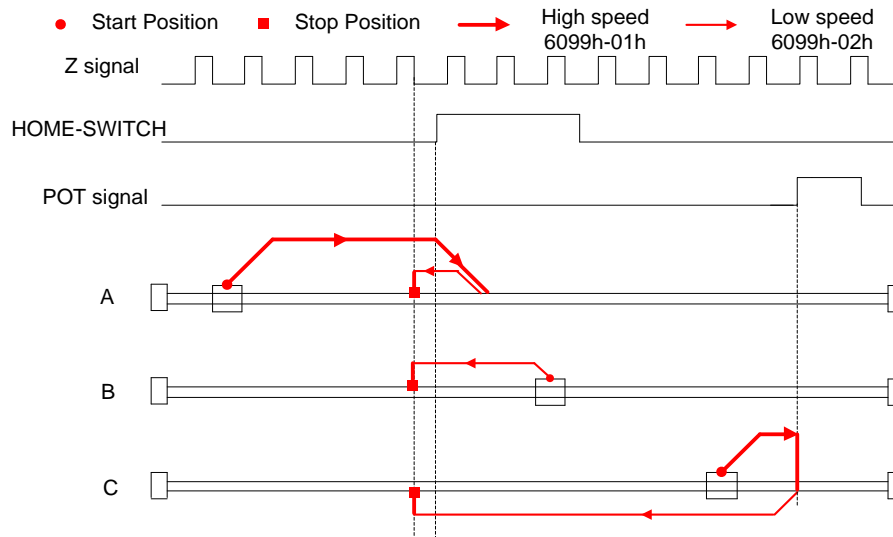
If the negative limit switch signal is valid during the homing process, the status word (6041h) bit 13 will be valid, indicating that the homing error and the motor will stop immediately.



Method 8:

If the homing switch and positive limit switch is invalid, the motor will move in positive direction at low speed. The motor stops after the homing switch valid and the first encoder Z signal is valid, as shown in figure.

If the positive limit switch is invalid and motor stops at the homing switch position when it starts to move, the motor will move in negative direction at high speed until the homing switch signal is invalid. Then the motor reverse the direction at low speed. The motor stops after the homing switch valid and the first encoder Z signal is valid, as shown in figure.

If the homing switch and positive limit switch is invalid, the motor will move in positive direction at low speed until the positive limit switch valid. Then the motor reverse the direction at high speed until the homing switch invalid. Then the motor move in positive direction at low speed. The motor stops after the homing switch valid and the first encoder Z signal is valid, as shown in figure.

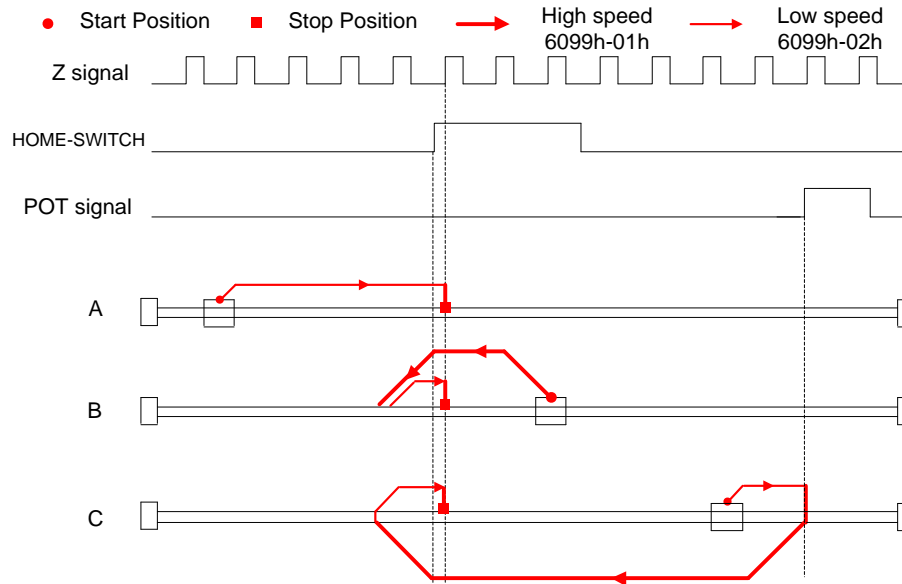
If the negative limit switch signal is valid during the homing process, the status word (6041h) bit 13 will be valid, indicating that the homing error and the motor will stop immediately.



Method 9:

If the homing switch and positive limit switch is invalid, the motor will move in positive direction at high speed until the homing switch invalid. Then the motor reverse the direction at low speed. The motor stops after the homing switch valid and the first encoder Z signal is valid, as shown in figure.

If the positive limit switch is invalid and motor stops at the homing switch position when it starts to move, the motor will move in positive direction at high speed until the homing switch signal is invalid. Then the motor reverse the direction at low speed. The motor stops after the homing switch valid and the first encoder Z signal is valid, as shown in figure.

If the homing switch and positive limit switch is invalid, the motor will move in positive direction at high speed until the positive limit switch valid. Then the motor reverse the direction at low speed. The motor stops after the homing switch valid and the first encoder Z signal is valid, as shown in figure.

If the negative limit switch signal is valid during the homing process, the status word (6041h) bit 13 will be valid, indicating that the homing error and the motor will stop immediately.

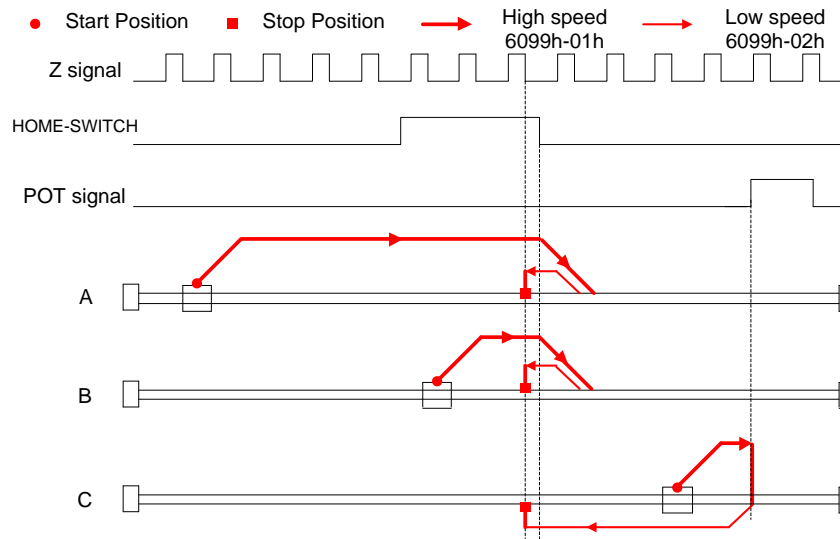

Method 10:

If the homing switch and positive limit switch is invalid, the motor will move in positive direction at low speed. The motor stops after the homing switch invalid and the first encoder Z signal is valid, as shown in figure.

If the positive limit switch is invalid and motor stops at the homing switch position when it starts to move, the motor will move in positive direction at low speed. The motor stops after the homing switch invalid and the first encoder Z signal is valid, as shown in figure.

If the homing switch and positive limit switch is invalid, the motor will move in positive direction at low speed until the positive limit switch valid. Then the motor reverse the direction at high speed until the homing switch valid. Then the motor move in positive direction at low speed. The motor stops after the homing switch invalid and the first encoder Z signal is valid, as shown in figure.

If the negative limit switch signal is valid during the homing process, the status word (6041h) bit 13 will be valid, indicating that the homing error and the motor will stop immediately.

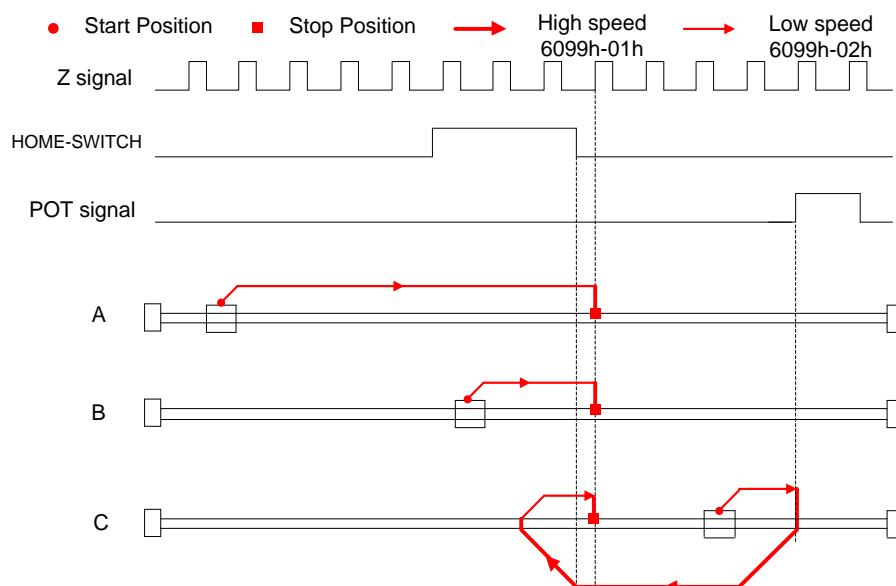

Method 11

If the homing switch and negative limit switch is invalid, the motor will move in negative direction at high speed until the homing switch signal is valid. Then the motor reverse the direction at low speed. The motor stops after leaving the homing switch and the first encoder Z signal is valid, as shown in figure.

If the negative limit switch is invalid and motor stops at the homing switch position when it starts to move, the motor will move in positive direction at low speed. The motor stops after leaving the homing switch and the first encoder Z signal is valid, as shown in figure.

If the homing switch and positive limit switch is invalid, the motor will move in negative direction at high speed until the negative limit switch valid. Then the motor reverse the direction at low speed. The motor stops after the homing switch invalid and the first encoder Z signal is valid, as shown in figure.

If the positive limit switch signal is valid during the homing process, the status word (6041h) bit 13 will be valid, indicating that the homing error and the motor will stop immediately.

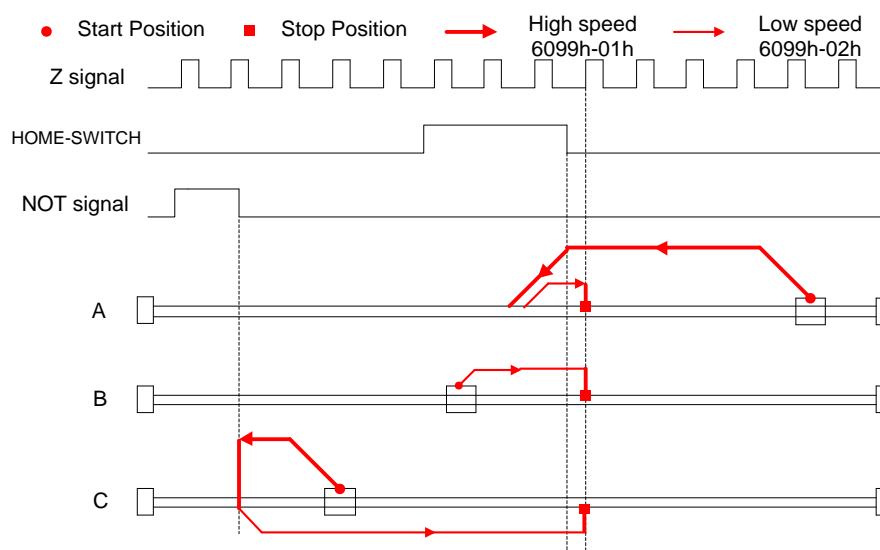

Method 12:

If the homing switch and positive limit switch is invalid, the motor will move in negative direction at low speed. The motor stops after the homing switch valid and the first encoder Z signal is valid, as shown in figure.

If the negative limit switch is invalid and motor stops at the homing switch position when it starts to move, the motor will move in positive direction at high speed until the homing switch signal is invalid. Then the motor reverse the direction at low speed. The motor stops after the homing switch valid and the first encoder Z signal is valid, as shown in figure.

If the homing switch and negative limit switch is invalid, the motor will move in negative direction at low speed until the positive limit switch valid. Then the motor reverse the direction at high speed until the homing switch invalid. Then the motor move in negative direction at low speed. The motor stops after the homing switch valid and the first encoder Z signal is valid, as shown in figure.

If the positive limit switch signal is valid during the homing process, the status word (6041h) bit 13 will be valid, indicating that the homing error and the motor will stop immediately.

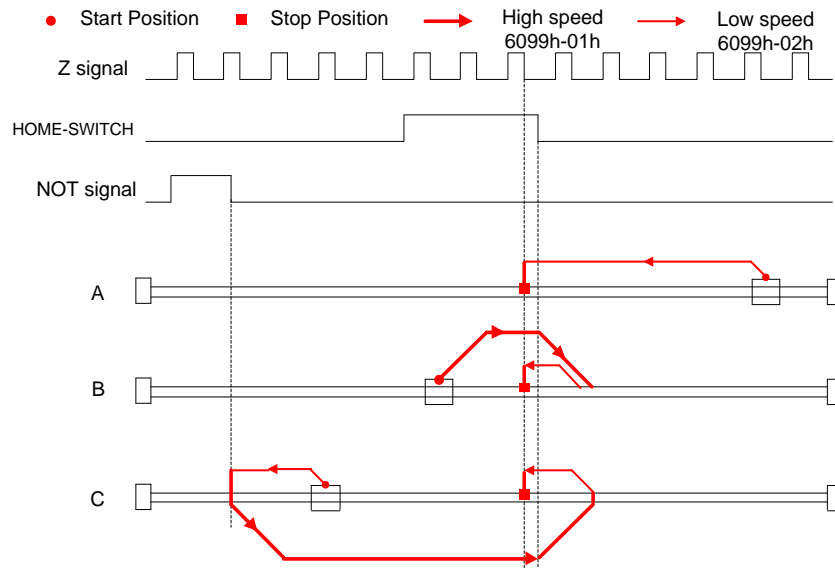

Method 13:

If the homing switch and negative limit switch is invalid, the motor will move in negative direction at high speed until the homing switch invalid. Then the motor reverse the direction at low speed. The motor stops after the homing switch valid and the first encoder Z signal is valid, as shown in figure.

If the negative limit switch is invalid and motor stops at the homing switch position when it starts to move, the motor will move in negative direction at high speed until the homing switch signal is invalid. Then the motor reverse the direction at low speed. The motor stops after the homing switch valid and the first encoder Z signal is valid, as shown in figure.

If the homing switch and positive limit switch is invalid, the motor will move in negative direction at high speed until the negative limit switch valid. Then the motor reverse the direction at low speed. The motor stops after the homing switch valid and the first encoder Z signal is valid, as shown in figure.

If the positive limit switch signal is valid during the homing process, the status word (6041h) bit 13 will be valid, indicating that the homing error and the motor will stop immediately.

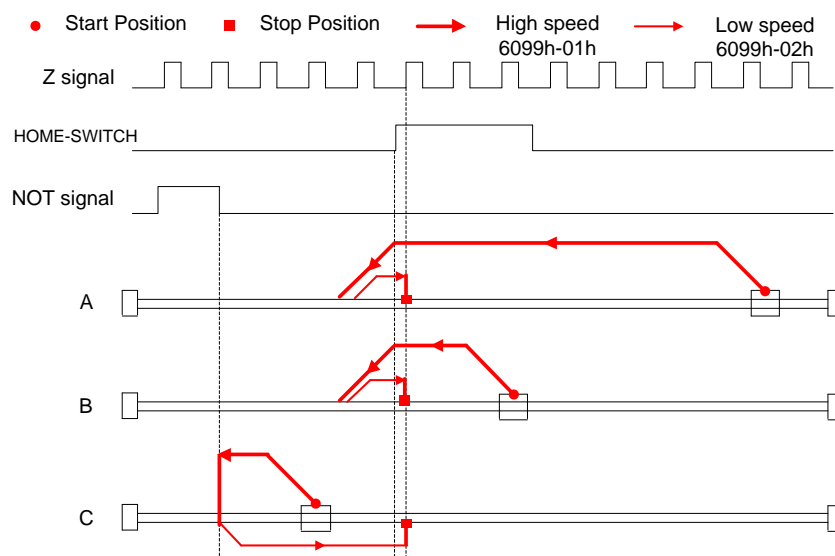

Method 14:

If the homing switch and positive limit switch is invalid, the motor will move in negative direction at low speed. The motor stops after the homing switch invalid and the first encoder Z signal is valid, as shown in figure.

If the negative limit switch is invalid and motor stops at the homing switch position when it starts to move, the motor will move in negative direction at low speed. The motor stops after the homing switch invalid and the first encoder Z signal is valid, as shown in figure.

If the homing switch and positive limit switch is invalid, the motor will move in negative direction at low speed until the negative limit switch valid. Then the motor reverse the direction at high speed until the homing switch valid. Then the motor move in negative direction at low speed. The motor stops after the homing switch invalid and the first encoder Z signal is valid, as shown in figure.

If the positive limit switch signal is valid during the homing process, the status word (6041h) bit 13 will be valid, indicating that the homing error and the motor will stop immediately.

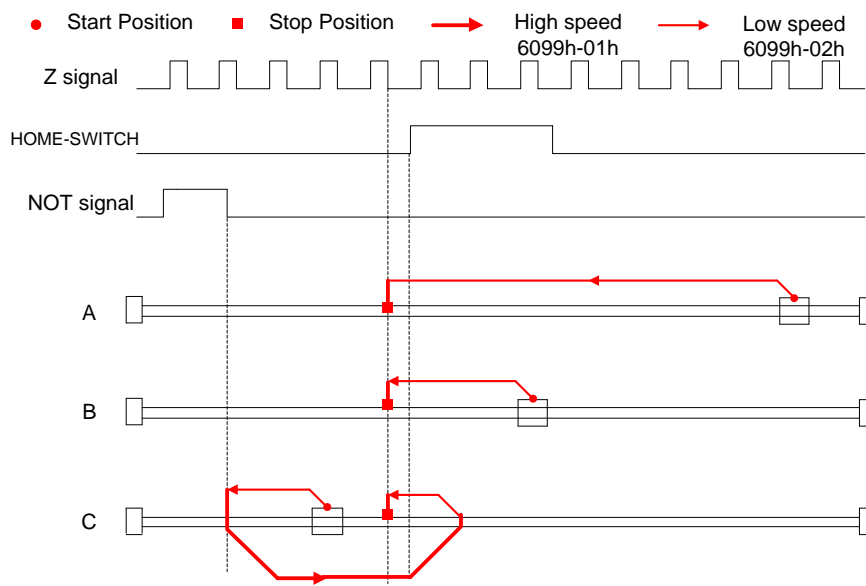
Method 17:

This method is similar to method 1

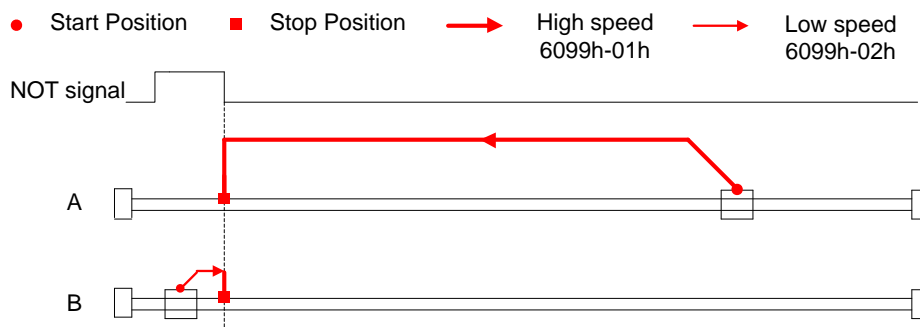
Method 18:

This method is similar to method 2

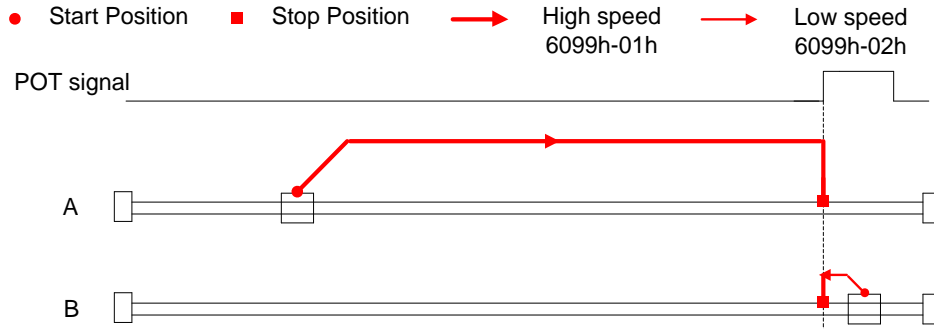
Method 19:

This method is similar to method 3

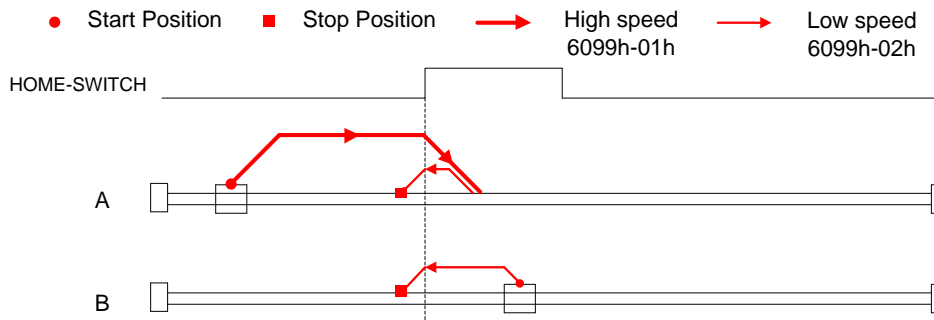
Method 20:

This method is similar to method 4

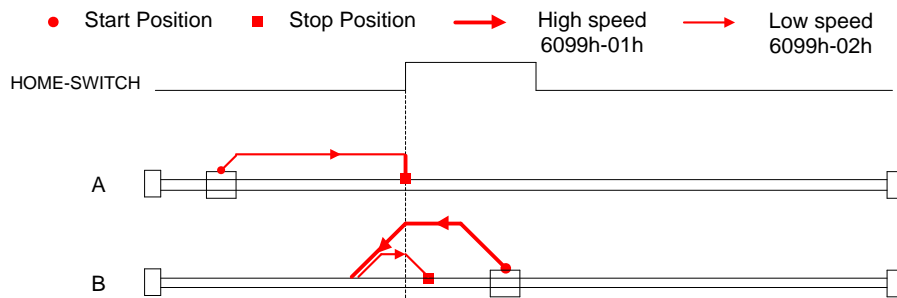
Method 21:

This method is similar to method 5

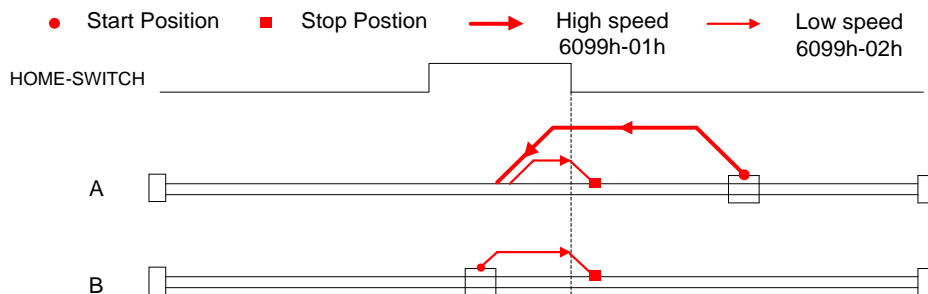
Method 22:

This method is similar to method 6

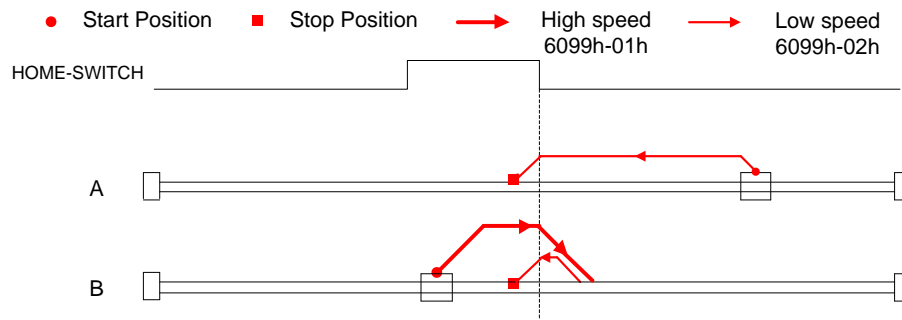
Method 23:

This method is similar to method 7

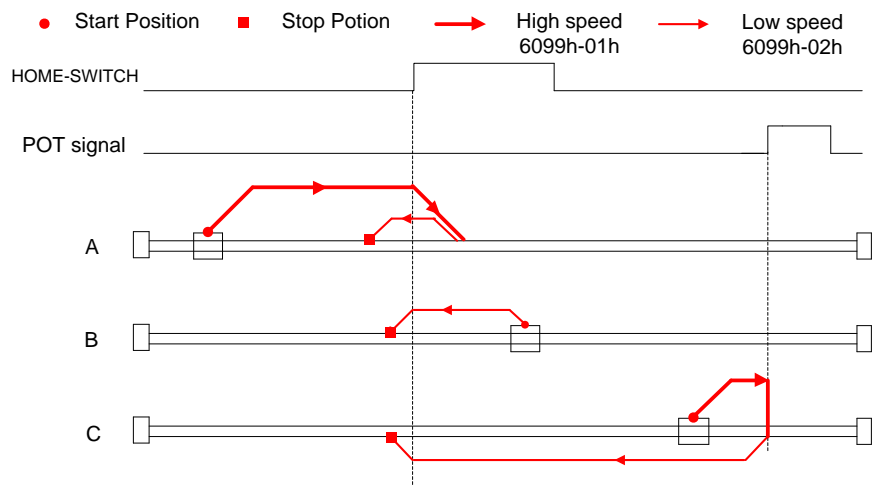
Method 24:

This method is similar to method 8

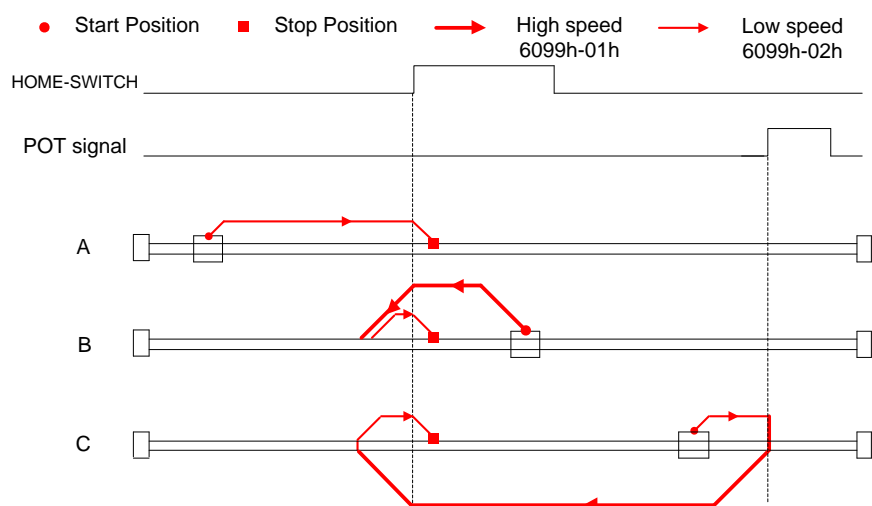
Method 25:

This method is similar to method 9

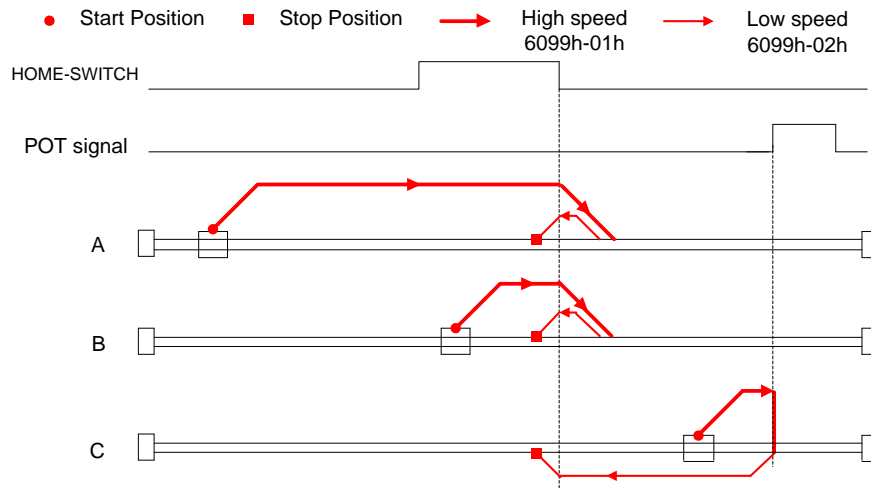
Method 26:

This method is similar to method 10

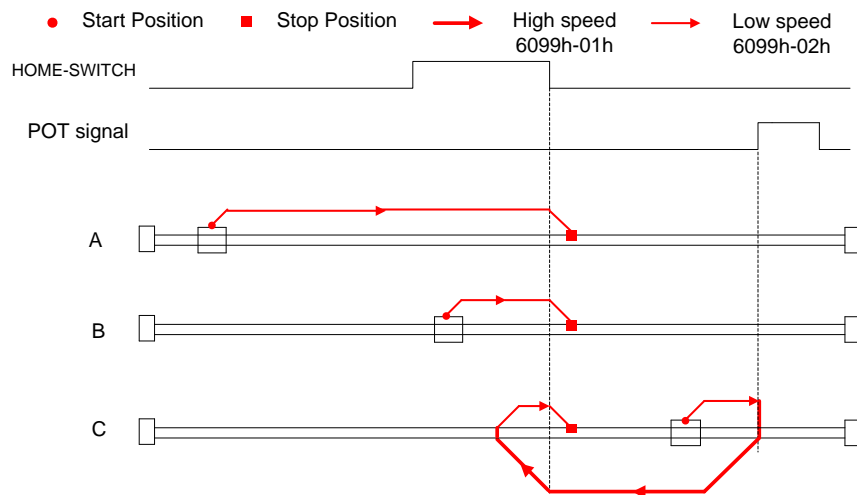

Method 27:

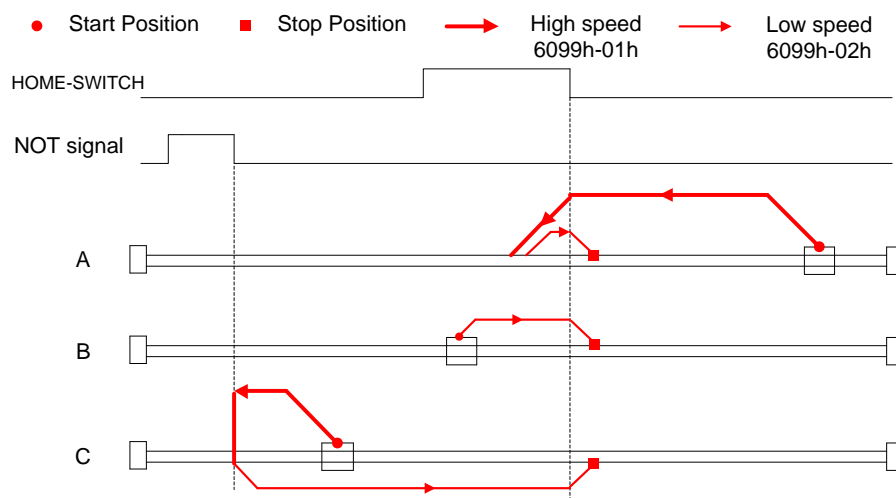
This method is similar to method 11

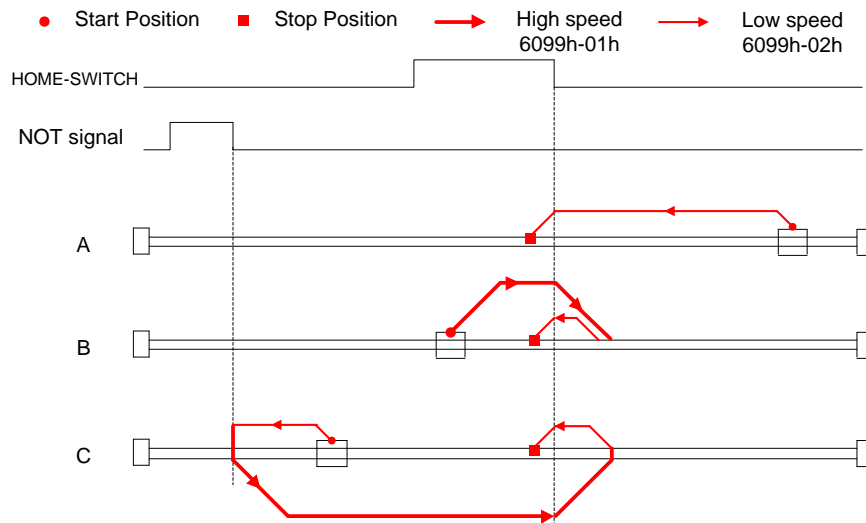

Method 28:

This method is similar to method 12

Method 29:

This method is similar to method 13

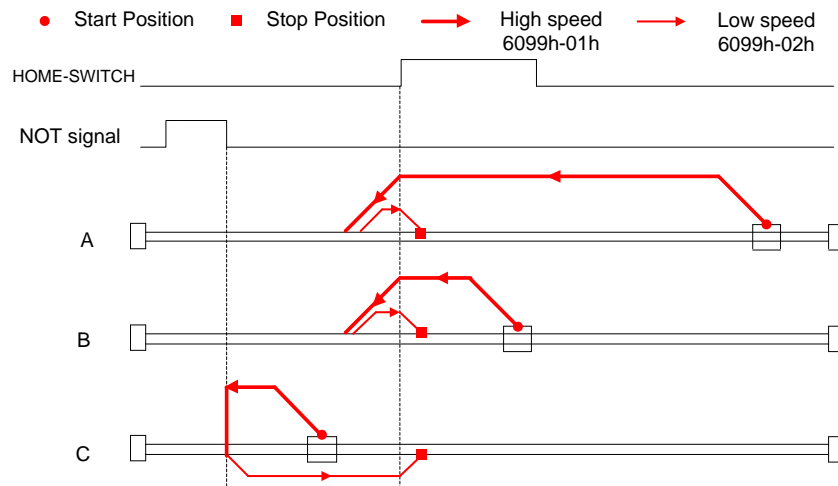
Method 30:

This method is similar to method 14

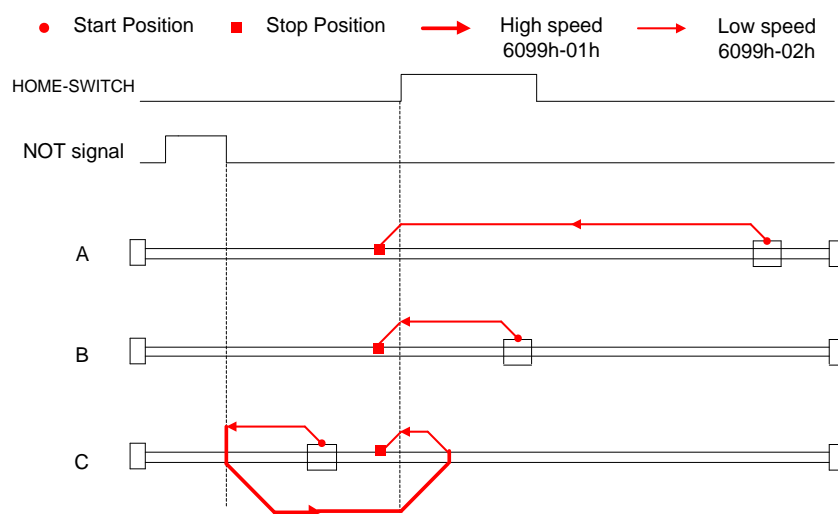

Method 33:

The motor starts to move in a negative direction and stops when the Z signal is valid.

If the positive/negative limit switch signal and homing switch is valid during the homing process, the status word (6041h) bit 13 will be valid, indicating that the homing error and the motor will stop immediately.

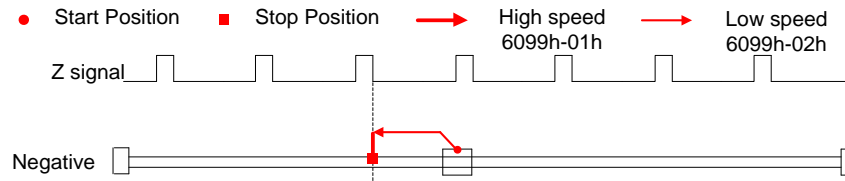
Method 34:

The motor starts to move in a positive direction and stops when the Z signal is valid.

If the positive/negative limit switch signal and homing switch is valid during the homing process, the status word (6041h) bit 13 will be valid, indicating that the homing error and the motor will stop immediately.

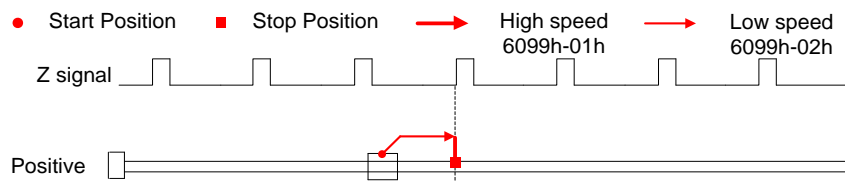
Method 35/37:

Set the current position as homing point.

When using this method, the motor does not need to be enabled, only the control word (6041h) needs to be executed from 0 to 1.

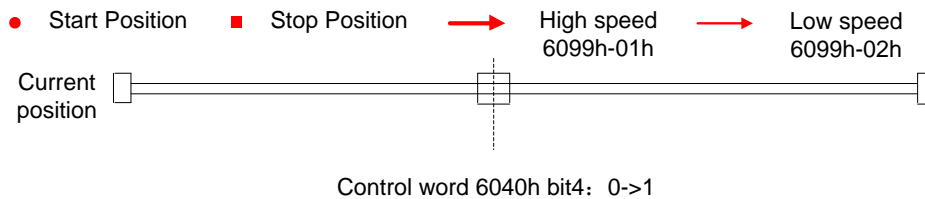

6.9 Security Features

6.9.1 BRK-OFF output

This function can be configured by set digital DO output functions allocation. refer to IO Pr4.10 parameter description. When the enable and time meet the set conditions, the digital output IO port can output ON.

Pr4.37	Name	Mechanical brake action at stalling setup			Mode							F
	Range	0~10000	Unit	1ms	Default	0	Index	2437h				
Motor brake delay time setup, mainly used to prevent servo on “galloping” phenomenon. Set up the time from when the brake release signal(BRK-OFF) turns off to when the motor is de-energized (servo-free),when the motor turns to servo-off while the motor is at stall												
<ul style="list-style-type: none"> Set up to prevent a micro-travel/drop of the motor (work) due to the action delay time(tb) of the brake. After setting up Pr4.37>=tb, then compose the sequence so as the drive turns to servo-off after the brake is 												

actually activated.

Pr4.38	Name	Mechanical brake action at running setup			Mode						F
	Range	0~10000	Unit	1ms	Default	0	Index	2438h			

Mechanical brake start delay time setup, mainly used to prevent servo off “galloping” phenomenon. Set up time from when detecting the off of servo-on input signal(SRV-ON) is to when external brake release signal(BRK-OFF) turns off, while the motor turns to servo off during the motor in motion.

- Set up to prevent the brake deterioration due to the motor running.
- At servo-OFF during the motor is running , t_b of the right fig will be a shorter one of either Pr4.38 setup time, or time lapse till the motor speed falls below Pr4.39 setup speed.

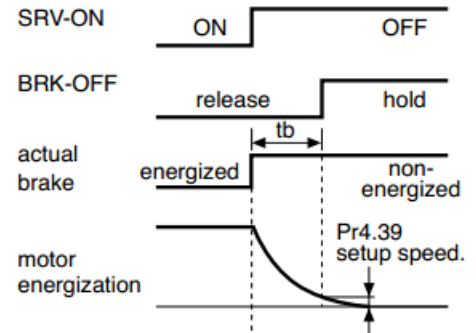

Pr4.39	Name	Brake release speed setup			Mode						F
	Range	30~3000	Unit	1ms	Default	30	Index	2439h			

Set up the speed timing of brake output checking during operation .

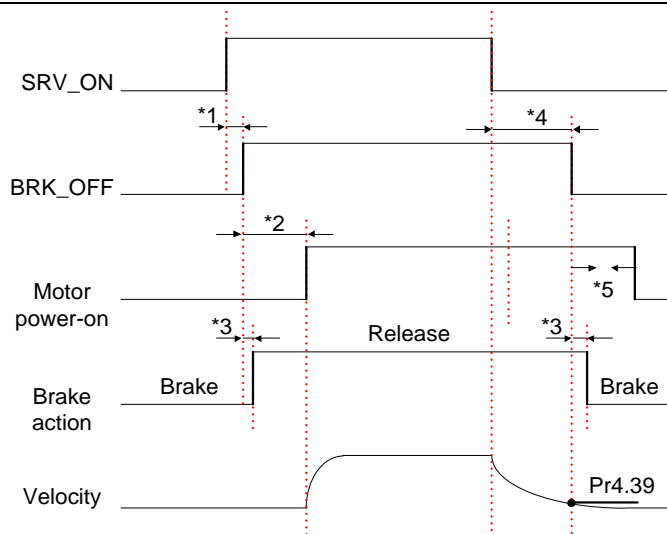

Notice:

- *1: The delay time between SRV_ON and BRK_OFF is less than 500ms;
- *2: Time setting in Pr4.38;
- *3: The delay time between the BRK_OFF signal output and the actual brake release action, which depends on the hardware characteristics of the motor brake;
- *4: The smaller value of Pr4.37 and Pr4.39;

6.9.2 Servo stop mode

Pr5.06	Name	Stop mode			Mode							F
	Range	0~1	Unit	—	Default	0	Index	2506h				
Specify the status during deceleration and after stop, after servo-off.												
Setup value		Details										
0		Disabled when disable signal effective and speed reduce to Pr4.39										
1		Disabled when disable signal effective, free-run to stop										

6.9.3 Emergency stop function

Pr5.11	Name	Torque setup for emergency stop			Mode							F
	Range	0~500	Unit	%	Default	0	Index	2511h				
Set up the torque limit at emergency stop When setup value is 0, the torque limit for normal operation is applied. Compared with the maximum torque 6072, the actual torque limit value is smaller one.												

6.10 Inertia ratio identification

Pr0.04	Name	Inertia ratio			Mode							F
	Range	0~10000	Unit	%	Default	250	Index	2004h				
You can set up the ratio of the load inertia against the rotor(of the motor)inertia. $\text{Pr0.04} = (\text{load inertia} / \text{rotate inertia}) \times 100\%$ Notice: If the inertia ratio is correctly set, the setup unit of Pr1.01 and Pr1.06 becomes (Hz). When the inertia ratio of Pr0.04 is larger than the actual value, the setup unit of the velocity loop gain becomes larger, and when the inertia ratio of Pr0.04 is smaller than the actual value, the setup unit of the velocity loop gain becomes smaller.												

6.10.1 On-line inertia ratio identification

The motor is operated by the controller, and the motor speed is above 400rpm. The running stroke has obvious acceleration, uniform speed and deceleration process, and the load inertia ratio can be tested by running 2-3 times continuously. The inertia ratio of the test is viewed in *Drive Operating Data Monitor*-> *d16Jr*. Set the monitor value minus 100 into Pr0.04..

6.10.2 Motion Studio inertia ratio identification

This inertia ratio identification function also added in Motion Studio configuration software.

Pre-conditions: 1、 Servo disable. 2、 Positive limit and negative limit invalid

Steps:

- 1、 Set the Jog speed Pr6.04, and the setting should not be too large(600~1000rpm is recommend)
Set the Acc Pr6.25(50~100 ms/1000rpm is recommend)
Set the Default Inertia Ratio.

Download these settings, then **Servo Enable**.

- 2、 Click “CCW” to make motor run to CCW direction, click “Position 1” to save the position limit 1
Click “CW” to make motor run to CW direction, click “Position 2” to save the position limit 2
Click “Run” to start Inertia ratio identification.

Inertia Ratio Identification X

STEP-1

Pr6.04 Jog Speed rpm Download

Pr6.25 Acceleration of trial running ms/1000rpm

Default Inertia Ratio Servo Enable ON

Invalid External Enable

STEP-2



Current r

Pr6.21 Waiting time of trial running ms Run

Pr6.22 Cycling times of trial running

STEP-3

Inertia Ratio Write

3、 After finishing, Click “Write” to save the Inertia ratio identification result.

6.11 Vibration Suppression

Specific resonance frequency can be obtained from PC configuration software according to waveform monitoring, and filter frequency can be set to effectively suppress the oscillation ripple of a certain frequency in the current instruction.

The width of the notch is the ratio of the frequency of the notch center at a depth of 0 to the frequency range width of the attenuation rate of -3db.

The depth of the trap is: when the set value is 0, the input of the center frequency is completely disconnected; When the set value is 100, it represents the ratio of input and output that are completely passed

How to use:

1. Set Pr2.00=1
2. Decrease Pr0.03 to get higher stiffness, higher position loop gain and velocity loop gain. Decrease Pr0.03 gradually, while abnormal sound or oscillation occurred, decrease the current value by 2.
3. Execute movement by controller or Motion Studio, drive will record notch frequency automatically.
4. Upload the drive parameters, the record notch frequency saved in Pr2.07.

Read the value of Pr2.07, and set this value into Pr2.01. Then reset Pr2.07 to 2000.

5. Saving parameters setting.

Pr2.00	Name	Adaptive filter mode setup			Mode								F
	Range	0~4	Unit	-	Default	0	Index			2200h			

Set up the resonance frequency to be estimated by the adaptive filter and the special the operation after estimation.

Setup value	Content	
0	Adaptive filter: invalid	Parameters related to the 3rd and 4th notch filter hold the current value.
1	Adaptive filter, 1 filter is valid, one time	One adaptive filter is valid, parameters related to the 3rd notch filter will be updated based on adaptive performance. After updated, Pr2.00 returns to 0, stop self-adaptation.
2	Adaptive filter, 1 filter is valid, It will be valid all the time	One adaptive filter is valid, parameters related to the 3rd notch filter will be updated all the time based on adaptive performance.
3-4	Not use	Non-professional forbidden to use

Pr2.01	Name	1st notch frequency			Mode								F
	Range	50~2000	Unit	Hz	Default	2000	Index			2201h			

Set the center frequency of the 1st notch filter

Notice: the notch filter function will be invalidated by setting up this parameter to “2000”.

Pr2.02	Name	1st notch width selection			Mode								F
	Range	0~20	Unit	-	Default	2	Index			2202h			

Set the width of notch at the center frequency of the 1st notch filter.

Notice: Higher the setup, larger the notch width you can obtain. Use with default setup in normal operation.

Pr2.03	Name	1st notch depth selection			Mode								F
	Range	0~99	Unit	-	Default	0	Index			2203h			

Set the depth of notch at the center frequency of the 1st notch filter.

Notice: Higher the setup, shallower the notch depth and smaller the phase delay you can obtain.

Pr2.04	Name	2nd notch frequency			Mode								F
	Range	50~2000	Unit	Hz	Default	2000	Index			2204h			

Set the center frequency of the 2nd notch filter

Notice: the notch filter function will be invalidated by setting up this parameter to “2000”.

Pr2.05	Name	2nd notch width selection			Mode								F
	Range	0~20	Unit	-	Default	2	Index			2205h			

Set the width of notch at the center frequency of the 2nd notch filter.

Notice: Higher the setup, larger the notch width you can obtain. Use with default setup in normal operation.

Pr2.06	Name	2nd notch depth selection			Mode															F
	Range	0~99	Unit	-	Default	0	Index			2206h										
Set the depth of notch at the center frequency of the 2nd notch filter. Notice: Higher the setup, shallower the notch depth and smaller the phase delay you can obtain.																				

6.12 Friction torque compensation

Pr6.07	Name	Torque command additional value			Mode																F
	Range	-100~100	Unit	%	Default	0	Index			2607h											
Pr6.08	Name	Positive direction torque compensation value			Mode																F
	Range	-100~100	Unit	%	Default	0	Index			2608h											
Pr6.09	Name	Negative direction torque compensation value			Mode																F
	Range	-100~100	Unit	%	Default	0	Index			2609h											
These three parameters may apply feed forward torque superposition directly to torque command.																					

6.13 Regenerative resister setting

When the torque of the motor is opposite to the direction of rotation (such as deceleration, z-axis falling down, etc.), energy will feedback to the drive. At this time, the energy feedback received by the capacitor in the drive, which makes the voltage of the capacitor rise. When it rises to a certain voltage value, the excess energy needs to be consumed by the regenerative resistance.

Pr0.16	Name	External regenerative resistance value			Mode																F
	Range	40~500	Unit	Ohm	Default	100	Index			2016h											
Set Pr.0.16 and Pr.0.17 to confirm the threshold value of the discharge loop to give alarm for over current.																					

Pr0.17	Name	External regenerative resistance power value			Mode																F
	Range	20~5000	Unit	W	Default	20	Index			2017h											
Set Pr.0.16 and Pr.0.17 to confirm the threshold value of the discharge loop to give alarm for over current.																					

Pr7.31	Name	Regenerative resistance control mode setting				Mode	P	S	T						
	Range	0~2	Unit	--	Default	0									
<table border="1" style="margin-left: auto; margin-right: auto;"> <thead> <tr> <th style="background-color: #008000; color: white;">Setup value</th> <th style="background-color: #008000; color: white;">Details</th> </tr> </thead> <tbody> <tr> <td style="text-align: center;">0</td> <td>Disable regenerative resistance discharge</td> </tr> <tr> <td style="text-align: center;">1</td> <td>Enable reactive pump lift suppression function</td> </tr> </tbody> </table>										Setup value	Details	0	Disable regenerative resistance discharge	1	Enable reactive pump lift suppression function
Setup value	Details														
0	Disable regenerative resistance discharge														
1	Enable reactive pump lift suppression function														

	2	Enable regenerative resistance discharge	
Notice:			

Pr7.32	Name	Regenerative resistance open threshold setting			Mode	P	S	T
	Range	20~90	Unit	V	Default	80		
The external resistance is activated when the actual bus voltage is higher than Pr7.32 plus Pr7.33 and is deactivated when the actual bus voltage is lower than Pr7.32 minus Pr7.33								
Notice:								

Pr7.33	Name	Regenerative resistance control hysteresis			Mode	P	S	T
	Range	1~50	Unit	V	Default	5		
The external resistance is activated when the actual bus voltage is higher than Pr7.32 plus Pr7.33 and is deactivated when the actual bus voltage is lower than Pr7.32 minus Pr7.33								
Notice:								

Chapter 7 Alarm and Processing

7.1 Alarm List

If an error has occurred, the red power LED will flash in a 5s cycle. When the fault is cleared the red power LED is always off.

The following table shows the meaning of the error numbers.

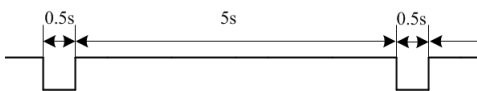
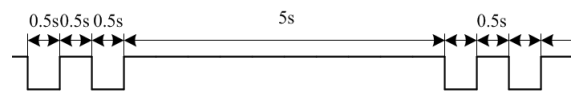
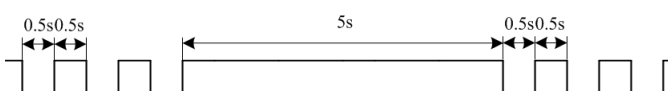
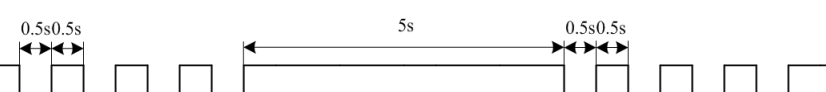
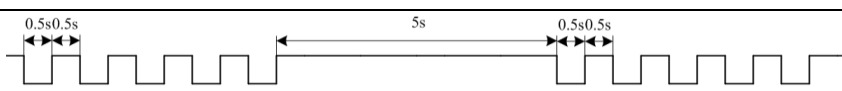
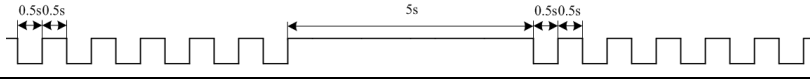
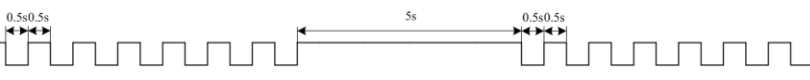
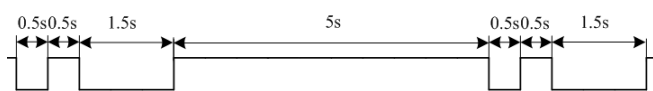
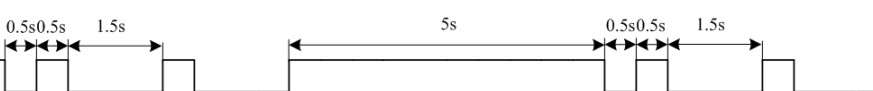
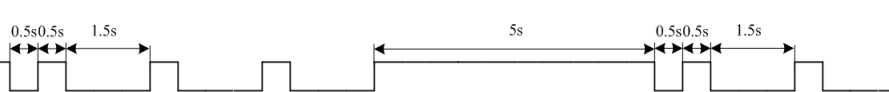
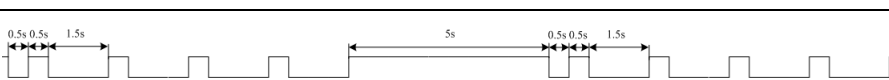
LED flashes	Time sequence	Errors
1 short		Over-current
2 short		DC bus over-voltage/ under-voltage
3 short		CAN communication timeout
4 short		Power line break
5 short		Encoder error
6 short		Over-load
7 short		Too large position pulse deviation
1 short 1 long		Motor speed out of control
1 short 2 long		current detection circuit error
1 short 3 long		CRC verification error
1 short 4 long		Other errors

The configuration software MotionStudio will automatically display the error code in alarm display window.

The history of the error can be also viewed on alarm window from the configuration software.

Table 7.1 Error Code List

603F(hex) Error code	1001(hex) Error register	Configuration software	Content
2211	2	0E0	Over-current
2212	2	0E1	Over-current of intelligent power module (IPM)
3150	4	0A0	Current detection circuit error
3151	4	0A1	Current detection circuit error
3153	4	0A3	Power line (U、V、W) break
3201	4	0A5	DC bus circuit error
3211	4	0C0	DC bus over-voltage
3221	4	0D0	DC bus under-voltage
4210	8	0F0	Drive over-heat
5530	80	240	CRC verification error when EEPROM parameter saved
5531	80	241	I ² C Communication status error
5532	80	242	Read/write history alarm error
5533	80	243	Read/write diagnostic data error
5534	80	244	Read/write bus communication parameters error
5535	80	245	Read/write 402 parameters error
6321	80	210	input interface allocation error
6322	80	211	input interface function set error
6323	80	212	output interface function set error
6329	80	090	FPGA communication error
7122	80	5F0	Motor code error
7321	80	150	Encoder wiring error
7322	80	151	Encoder data error
7323	80	152	Encoder initial position error
7324	80	170	Encoder data error
7329	80	260	Positive/negative limit input active
7701	80	120	Brake resistor discharged circuit overload

7702	80	121	Brake resistor error
8110	10	901	CAN bus over-run
8120	10	902	CAN in error passive mode
8130	10	903	Lifeguard error
8140	10	904	Recovered from CAN bus off.
8141	10	905	CAN Bus off occurred.
8150	10	906	ID error
8310	2	101	Motor over-load
8311	2	100	Drive over-load
8305	2	105	Torque saturation alarm
8401	20	190	Vibration is too large
8402	20	1A0	Over-speed 1
8403	20	1A1	Motor speed out of control
8503	20	1B1	Electronic gear ratio error
8611	20	180	Too large position pulse deviation
8610	20	181	Too large velocity deviation
8612	20	1B0	Position pulse input frequency error

7.2 Alarm Processing Method

When error occurred, please clear error reason, restart the power supply.

Error code	Main	Extra	Display: "E88090"_"E8809E"
	E9	E~F	Content: FPGA communication error
Cause	Confirmation		Solution
Vdc/GND under-voltage	Check the voltage of Vdc/GND terminal		Make sure voltage of Vdc/GND in proper range
Drive internal fault	/		replace the drive with a new one

Error code	Main	Extra	Display: "E2E000"..."E2E0A1"
	E2	0~1	Content: current detection circuit error
Cause			Confirmation
Wiring error of motor output U,V,W terminal			Check wiring of motor output U,V,W terminal
Vdc/GND under-voltage			Check the voltage of Vdc/GND terminal
Drive inner fault			/
			Solution
Wiring error of motor output U,V,W terminal			Make sure motor U,V,W terminal wiring correctly
Vdc/GND under-voltage			Make sure voltage of Vdc/GND in proper range
Drive inner fault			replace the drive with a new one

Error code	Main	Extra	Display: "E2E0A2"..."E2E0A4"
	E2	2~4	Content: analog input circuit error
Cause			Confirmation
Analog input Wiring error			Check wiring of analog input
Drive inner fault			/
			Solution
Analog input Wiring error			Make sure analog input wiring correctly
Drive inner fault			replace the drive with a new one

Error code	Main	Extra	Display: "E2E0A3"
	E2	3	Content: Power line break
Cause			Confirmation
Power line break			Check wiring of analog input
Drive inner fault			/
			Solution
Power line break			Use a multimeter to measure the resistance between the winding wires. If the three-phase resistance is inconsistent, the winding may be open or the motor may be damaged
Drive inner fault			replace the motor with a new one

Error code	Main	Extra	Display: "E2E0A5"
	E2	5	Content: DC bus circuit error
Cause			Confirmation
Vdc/GND under-voltage			Check the voltage of Vdc/GND terminal
Drive inner fault			/
			Solution
Vdc/GND under-voltage			Make sure voltage of Vdc/GND in proper range
Drive inner fault			replace the drive with a new one

Error code	Main	Extra	Display: "E2E0A6"
	E2	6	Content: temperature detection circuit error
Cause			Confirmation
Vdc/GND under-voltage			Check the voltage of Vdc/GND terminal
Drive inner fault			/
			Solution
Vdc/GND under-voltage			Make sure voltage of Vdc/GND in proper range
Drive inner fault			replace the drive with a new one

Error code	Main	Extra	Display: "E2E0E0"
	E2	0	Content: control power under-voltage
Cause			Confirmation
Vdc/GND under-voltage			Check the voltage of Vdc/GND terminal
Drive inner fault			/
			Solution
Vdc/GND under-voltage			Make sure voltage of Vdc/GND in proper range
Drive inner fault			replace the drive with a new one

Error code	Main	Extra	Display: "E2E0E2"
	E2	0	Content: DC bus over-voltage
Cause			Confirmation
Vdc/GND over-voltage			Check the voltage of Vdc/GND terminal
Inner brake circuit damaged			/
Drive inner fault			/
			Solution
Vdc/GND over-voltage			Make sure voltage of Vdc/GND in proper range
Inner brake circuit damaged			replace the drive with a new one
Drive inner fault			replace the drive with a new one

Error code	Main	Extra	Display: "E2E0E0"
	E0	0	Content: DC bus under-voltage
Cause			Confirmation
Vdc/GND under-voltage			Check the voltage of Vdc/GND terminal
Drive inner fault			/
			Solution
Vdc/GND under-voltage			Make sure voltage of Vdc/GND in proper range
Drive inner fault			replace the drive with a new one

Error code	Main	Extra	Display: "E2E0E2"
	E2	0	Content: over-current
Cause			Confirmation
Short of drive output wire			Short of drive output wire, whether short circuit to PG ground or not
Abnormal wiring of motor			Check motor wiring order
Short of IGBT module			Cut off drive output wiring, make srv_on available and drive motor, check whether over-current exists
abnormal setting of control parameter			Modify the parameter
abnormal setting of control command			Check control command whether command changes too violently or not
			Solution
Short of drive output wire			Assure drive output wire no short circuit, assure motor no damage
Abnormal wiring of motor			Adjust motor wiring sequence
Short of IGBT module			replace the drive with a new one
abnormal setting of control parameter			Adjust parameter to proper range
abnormal setting of control command			Adjust control command: open filter function

Error code	Main	Extra	Display: "E2E0E2"
	E2	1	Content: IPM over-current
Cause			Confirmation
Short of drive output wire			Short of drive output wire, whether short circuit to PG ground or not
Abnormal wiring of motor			Check motor wiring order
			Solution
Short of drive output wire			Assure drive output wire no short circuit, assure motor no damage
Abnormal wiring of motor			Adjust motor wiring sequence

Short of IGBT module	Cut off drive output wiring, make srv_on available and drive motor, check whether over-current exists or not	replace the drive with a new one
Short of IGBT module	/	replace the drive with a new one
abnormal setting of control parameter	Modify the parameter	Adjust parameter to proper range
abnormal setting of control command	Check control command whether command changes too violently or not	Adjust control command: open filter function

Error code	Main	Extra	Display: "E28000"
	0F	0	Content: drive over-heat
Cause		Confirmation	Solution
the temperature of power module have exceeded upper limit		Check drive radiator whether the temperature is too high or not	Strengthen cooling conditions, promote the capacity of drive and motor, enlarge acceleration/deceleration time, reduce load

Error code	Main	Extra	Display: "E28100"
	10	0	Content: motor over-load
Cause		Confirmation	Solution
Load is too heavy		Check actual load if the value of parameter exceed maximum or not	Decrease load, adjust limit parameter
Oscillation of machine		Check the machine if oscillation exists or not	Modify the parameter of control loop; enlarge acceleration/deceleration time
wiring error of motor		Check wiring if error occurs or not, if line breaks or not	Adjust wiring or replace encoder/motor for a new one
electromagnetic brake engaged		Check brake terminal voltage	Cut off brake

Error code	Main	Extra	Display: "E2810-1"
	10	-1	Content: Motor overload/drive overload
Cause		Confirmation	Solution
Power line connection error		UVW connection error	Check connection of UVW
Over current		Over current	Use another drive with higher rated power

Error code	Main	Extra	Display: "E28120"
	12	0	Content: Resistance discharge circuit over-load
Cause		Confirmation	Solution
Regenerative energy has exceeded the capacity of regenerative resistor .		Check the speed if it is too high. Check the load if it is too large or not.	lower motor rotational speed; decrease load inertia ,increase external regenerative resistor, improve the capacity of the drive and motor
Resistance discharge circuit damage		/	Increase external regenerative resistor, replace the drive with a new one

Error code	Main	Extra	Display: "E28821"
	E2	1	Content: Leakage triode malfunction
Cause		Confirmation	Solution
Brake circuit failure		Brake resistance short circuit	repair
		IGBT damaged	repair

Error code	Main	Extra	Display: "E28810"
	E15	0	Content: encoder line brokeed
Cause		Confirmation	Solution
Encoder line disconnected		check wiring if it steady or not	Make encoder wiring steady
Encoder wiring error		Check encoder wiring if it is correct or not	Reconnect encoder wiring
Encoder damaged		/	replace the motor with a new one
Encoder measuring circuit damaged		/	replace the drive with a new one

Error code	Main	Extra	Display: "E28811"
	E15	1	Content: Encoder communication error
Cause		Confirmation	Solution
Encoder communication error		Interference is caused by noise	

Error code	Main	Extra	Display: "E28812"
	E15	2	Content: initialized position of encoder error
Cause		Confirmation	Solution
Communication data abnormal		Check encoder power voltage if it is $DC5V \pm 5\%$ or not; check encoder cable and shielded line if it is damaged or not; check encoder cable whether it is intertwined with other power wire or not	Ensure power voltage of encoder normally, ensure encoder cable and shielded line well with FG ground, ensure encoder cable separated with other power wire
Encoder damaged		/	replace the motor with a new one
Encoder measuring circuit damaged		/	replace the drive with a new one

Error code	Main	Extra	Display: "E28810"
	E17	0	Content: encoder data error
Cause		Confirmation	Solution
Communication data abnormal		Check encoder power voltage if it is $DC5V \pm 5\%$ or not ; check encoder cable and shielded line if it is damaged or not; check encoder cable whether it is intertwined with other power wire or not	Ensure power voltage of encoder normally, ensure encoder cable and shielded line well with FG ground, ensure encoder cable separated with other power wire
Encoder damaged		/	replace the motor with a new one
Encoder measuring		/	replace the drive with a new one

circuit damaged		
-----------------	--	--

Error code	Main	Extra	Display: "E28888"
	E8	0	Content: position error over-large error
Cause		Confirmation	Solution
Unreasonable set of position error parameter		Check parameter Pr_014 value if it is too small or not	Enlarge the value of Pr_014
Gain set is too small		Check parameter Pr_100, Pr_105 value if it is too small or not	Enlarge the value of Pr_100, Pr_105
Torque limit is too small		Check parameter Pr_013, Pr_522 value whether too small or not	Enlarge the value of Pr_103, Pr_522
Outside load is too large		Check acceleration/ deceleration time if it is too small or not , check motor rotational speed if it is too big or not ; check load if it is too large or not	Increase acceleration/ deceleration time decrease speed, decrease load

Error code	Main	Extra	Display: "E28888"
	E8	1	Content: velocity error over-large error
Cause		Confirmation	Solution
The deviation of inner position command velocity is too large with actual speed		Check the value of Pr_602 if it is too small or not	Enlarge the value of Pr_602, or set the value to 0, make position deviation over-large detection invalid
The acceleration/ decelerate time Inner position command velocity is too small		Check the value of Pr_312, Pr_313 if it is too small or not	Enlarge the value of Pr_312, Pr_313. adjust gain of velocity control, improve trace performance.

Error code	Main	Extra	Display: "E288190"
	E9	0	Content: excessive vibration
Cause		Confirmation	Solution
Current vibration		Current vibration	Cut down the value of Pr003. Pr004
Stiffness is too strong		Stiffness is too strong	

Error code	Main	Extra	Display: "E2881A0"
	EA	0	Content: over-speed 1
Cause		Confirmation	Solution
Motor speed has exceeded the first speed limit (Pr_321)		Check speed command if it is too large or not; check the voltage of analog speed command if it is too large or not; check the value of Pr_321 if it is too small or not; check input frequency and division frequency coefficient of command pulse if it is proper or not; check encoder if the wiring is correct or not	Adjust the value of input speed command, enlarge the value Pr_321 value, modify command pulse input frequency and division frequency coefficient, assure encoder wiring correctly

Error code	Main	Extra	Display: "E2888A1"
	E1A	1	Content: Motor speed out of control
Cause		Confirmation	Solution
UVW connection error		UVW connection error	
Encoder error		Encoder error	Replace motor
Special function			Set Pr1.37=4

Error code	Main	Extra	Display: "E2888B0"
	E1B	0	Content: Wrong pulse input frequency
Cause		Confirmation	Solution
Wrong pulse input frequency			

Error code	Main	Extra	Display: "E2888B1"
	E1B	1	Content: Electronic gear ratio error
Cause		Confirmation	Solution
Pulse input frequency is too high		Pulse input frequency is too high	Make sure the pulse frequency is below 500K

Error code	Main	Extra	Display: "E2882A0"
	E2A	0	Content: I/F input interface allocation error
Cause		Confirmation	Solution
The input signal are assigned with two or more functions.		Check the value of Pr_400, Pr_401, Pr_402, Pr_403, Pr_404 if it is proper or not	Assure the value of Pr_400, Pr_401, Pr_402, Pr_403, Pr_404 set correctly
The input signal aren't assigned with any functions.		Check the value of Pr_400, Pr_401, Pr_402, Pr_403, Pr_404 if it is proper or not	Assure parameter Pr_400, Pr_401, Pr_402, Pr_403, Pr_404 set correctly

Error code	Main	Extra	Display: "E2882A1"
	E2A	1	Content: I/F input interface function set error
Cause		Confirmation	Solution
Signal allocation error		Check the value of Pr_400, Pr_401, Pr_402, Pr_403, Pr_404 if it is proper or not	Assure the value of Pr_400, Pr_401, Pr_402, Pr_403, Pr_404 set correctly

Error code	Main	Extra	Display: "E2882A2"
	E2A	2	Content: I/F input interface function set error
Cause		Confirmation	Solution
The input signal are assigned		Check the value of Pr_410,	Assure the value of Pr_410, Pr_411,

with two or more functions.	Pr_411, Pr_412, Pr_413, if it is proper or not	Pr_412,Pr_413 set correctly
The input signal aren't assigned with any functions.	Check the value of Pr_410, Pr_411, Pr_412, Pr_413, if it is proper or not	Assure the value of Pr_410, Pr_411,Pr_412,Pr_413 set correctly

Error code	Main	Extra	Display: "E240"
	24	0	Content: CRC verification error when EEPROM parameter is saved
Cause		Confirmation	Solution
Vdc/GND under-voltage		Check the voltage of Vdc/GND terminal	Make sure voltage of Vdc/GND in proper range
Drive is damaged		save the parameters for several times	replace the drive with a new one
The setting of drive maybe default setting which isn't suitable for motor .		Check the setting of drive if it is suitable for your motor	Download the suitable project file to drive for motor

Error code	Main	Extra	Display: "E260"
	26	0	Content: positive negative over-travel input valid
Cause		Confirmation	Solution
positive /negative over-travelling input signal has been conducted		Check the state of positive negative over-travel input signal	/

Error code	Main	Extra	Display: "E270"
	27	0	Content: Analog value 1 input error limit
Cause		Confirmation	Solution
Analog value 1 input error limit		Analog value 1 input error limit	

Error code	Main	Extra	Display: "E570"
	57	0	Content: forced alarm input valid
Cause		Confirmation	Solution
Forced-alarm input signal has been conducted		Check forced-alarm input signal	Assure input signal wiring correctly

Error code	Main	Extra	Display: "E5E0"
	5E	0	Content: Motor code error
Cause		Confirmation	Solution
Motor code error		Motor code error	Set Pr7.15 correctly

Chapter 8 Product Accessory



Notice

Contact tech@leadshine.com if you need more technical service.

8.1 Accessory selection

1. Software configuration cable

CABLE-PC-1

2. CAN communication cable

CABLE-TX1M0-iSV2

CABLE-TX1M0-iSV2-LD2

CABLE-TX2M0-iSV2

CABLE-TX2M0-iSV2-LD2

3. Regenerative resistor (for application with big ACC and DEC)

10Ω+/-5%, 100w RXFB-1, Part num Code : 10100469

Contact us

China Headquarters

Address: 11/F, Block A3, iPark, No.1001 Xueyuan Blvd, Nanshan District, Shenzhen

Technical Support

Tel: 86-755-2641-8447

86-755-2641-8774 (for Asia, Australia, Africa areas)

86-755-2665-5136 (for America areas)

86-755-8654-2465 (for Europe areas)

Fax: 86-755-2640-2718

Email: tech@leadshine.com (for All)

Sales

Tel: 86-755-2641-7674 (for Asia, Australia, Africa areas)

86-755-2640-9254 (for Europe areas)

86-755-2641-7617 (for America areas)

Email: sales@leadshine.com